



VENTURE OIL & GAS, INC.

OIL AND GAS EXPLORATION, DEVELOPMENT & OPERATIONS

140 MAYFAIR ROAD, SUITE 900
HATTIESBURG, MS 39402

PHONE: 601-428-7725
Fax: 601-450-4448

July 31, 2023

Ms. Krystal Rudolph, P.E. Chief
Environmental Permits Division
Mississippi Department of Environmental Quality
PO Box 2261
Jackson, MS 39225-2261



Dear Ms. Rudolph:

Re: Venture Oil & Gas Inc. King 9-12 No. 1 Tank Battery
Oil Production General Permit NOI

Venture Oil & Gas Inc. is submitting the enclosed NOI for coverage under the Oil Production General Permit for the proposed King 9-12 No. 1 facility in Jasper County, MS. Also enclosed is a copy of the public notice which is to be published August 2, 2023.

If you have any questions, please feel free to contact me at (601) 428-2257.

Sincerely,

Dan Watts
HSE Director

Oil Production General Permit Public Notice
Mississippi Environmental Quality Permit Board
P. O. Box 2261
Jackson, Mississippi 39225
Telephone No. (601) 961-5171

Public Notice Start Date: 8/2/2023

Venture Oil & Gas King 9-12 No. 1 facility located at latitude 31.84714, longitude -89.31565, in Jasper County approximately 3.25 miles southwest of Stringer, Mississippi, (601) 518-0622, has applied to the Mississippi Department of Environmental Quality (MDEQ) for coverage under MDEQ's Oil Production General Permit to construct and operate an oil production facility.

The Oil Production General Permit has been developed to ensure compliance with all State and Federal regulations. Facilities granted coverage under this permit and adhering to the conditions contained therein should operate within State and Federal environmental laws and standards concerning the operation of air emissions equipment.

The proposed project consists of construction and/or operation of an oil and gas production site including well, separators, oil and water storage tanks, engines for a well pump and compressor, and a flare to control gas emissions. Venture is requesting a federally enforceable permit requirement that the storage tank emissions be routed to the flare at all times the facility is in operation. The facility will operate control(s) such that criteria pollutant emissions will not exceed emission rates restricted in the Oil Production General Permit, nor will hazardous air pollutant (HAP) emissions exceed any HAP emission rates restricted in the Oil Production General Permit. This project will result in new sources of potential emissions of regulated air pollutants. However, emissions will be below the Prevention of Significant Deterioration significance levels as specified in the Mississippi Regulations for the Prevention of Significant Deterioration of Air Quality, 11 Miss. Admin. Code Pt. 2, Ch. 5., and in 40 CFR Part 52.21. Potential emissions will also be below the Air Title V Major Source thresholds as specified in 11 Miss. Admin. Code Pt. 2, Ch. 6. and in 40 CFR Part 70.

Persons wishing to comment upon or object to the proposed request are invited to submit comments in writing to the **Air 1 Branch Chief, Environmental Permits Division** at the Permit Board's address shown above no later than 30-days from the date of publication of this notice. All comments received or postmarked by this date will be considered in the determination regarding the coverage approval. After receipt of public comments and thorough consideration of all comments, MDEQ will formulate its recommendations regarding coverage approval.

Additional details about the proposed project are available by writing or calling the **Air 1 Branch Chief, Environmental Permits Division** at the above Permit Board address and telephone number and on the MDEQ's website at: <https://www.mdeq.ms.gov/ensearch/recently-received-general-permit-noi/>. This information is also available for review at the following locations during normal business hours:

Mississippi Department of Environmental Quality
Office of Pollution Control
515 East Amite Street,
Jackson, MS 39201
(601) 961-5171

Bay Springs Municipal Library
2747 Highway 15
Bay Springs, MS 39153

Please bring the foregoing to the attention of persons whom you know will be interested.

OIL PRODUCTION GENERAL PERMIT NOTICE OF INTENT



VENTURE OIL & GAS, INC
King 9-12 No.1 Facility
Jasper County, Mississippi

Submittal Date: August 2023

PREPARED BY:

FC&E ENGINEERING, LLC
917 MARQUETTE ROAD
BRANDON, MISSISSIPPI 39042
(601) 824-1860



EXECUTIVE SUMMARY

Venture Oil & Gas Inc. (Venture) plans to drill a new well for the purposes of oil and gas production. The well (King 9-12 No. 1) will be located in Section 9, Township 10N, Range 13W, in Jasper County, Mississippi. The proposed site will include a conventional tank battery, flare, and associated well pad activities. Based on engineering estimates, the maximum production rates are estimated to be up to 750 thousand cubic feet (MCF) of gas produced per day and 350 barrels (bbl) of oil produced per day, along with 10 bbl/day of produced water.

A pipeline outlet does not currently exist for the gas, therefore, Venture proposes to flare the produced gas. If/when gas sales become available, all gas will be sold except for low pressure streams such as the storage tank emissions and the gas produced by low pressure separators. Venture will collect produced water into a 400-bbl water tank prior to offsite transport to a disposal well. Oil will be collected into three (3) 400-bbl oil storage tanks and one(1) 500 bbl oil storage tank before being trucked to market. Venture will route emissions from the oil and water storage tanks, as well as the heater treater, to the flare, and is requesting a federally enforceable requirement for flaring of tank emissions. Emissions associated with truck loading will be vented to the atmosphere. Venture may also operate various small chemical storage vessels, including totes and drums, which are typically associated with well pad activities. Venture intends to install and operate a natural gas fueled engine if/when a pumping unit is required for production from the well. Venture also plans to install a natural gas fueled engine to power a gas compressor, if needed, to allow for the transport of the natural gas to sales. These engines will be classified as "existing" under 40 CFR 63, Subpart ZZZZ. The compressor will be manufactured prior to 2014.

Consequently, Venture is submitting the attached Notice of Intent (NOI) and associated information for issuance of coverage under the Oil Production General Permit. Based on the facility's potential to emit, the facility's uncontrolled potential emissions of Volatile Organic Compounds (VOC), n-hexane, and total HAPs exceed the threshold limits to be classified as a True Minor Source. Therefore, Venture proposes to restrict facility operations such that the flare is operated at all times during gas venting. Combustion of produced gas from the well during possible upsets or unavailability of gas sales, process gas from the low pressure separators, and gas off of the oil and water storage tanks will ensure VOC emissions from the facility do not exceed the Air Title V Major Source threshold of 100 tons per year and the General permit limit of 95 tons per year. Venture will monitor the volume of gas sold and the volume of gas flared, except that the volume of gas from the tanks will be calculated using an approved methodology. Venture will calculate corresponding monthly VOC emissions due to flaring of gas from all sources. A flow meter will be used to measure monthly flow of produced gas to the flare. Monthly oil production records and E&P TANKS software will be utilized to calculate emissions from the storage tanks to the flare. Emissions calculations will be maintained on a monthly and rolling, consecutive 12-month basis to ensure compliance with permitted emissions thresholds.

Also included with the NOI are associated maps and figures. Detailed air emissions calculations are provided in Appendix A, and pertinent backup documentation is provided in Appendix B.

NOTICE OF INTENT (NOI) FORMS

**MDEQ NOTICE OF INTENT FOR COVERAGE UNDER THE OIL
PRODUCTION GENERAL PERMIT TO CONSTRUCT/OPERATE AIR
EMISSIONS EQUIPMENT AT A SYNTHETIC MINOR SOURCE**

Facility (Agency Interest) Information

Section OPGP - A

1. Name, Address, and Location of Facility

A. Owner/Company Name: Venture Oil & Gas Inc.

B. Facility Name (if different than A. above): Venture King 9-12 No. 1 Facility

C. Facility Air Permit/Coverage No. (if known): _____

D. Agency Interest No. (if known): _____

E. Physical Address

1. Street Address: Field Road off of Jasper County Road 7

2. City: Stringer 3. State: MS

4. County: Jasper 5. Zip Code: 39481

6. Telephone No.: 601-518-0622 7. Fax No.: _____

8. Are facility records kept at this location? Yes No. Please complete Item 10.

F. Mailing Address

1. Street Address or P.O. Box: 207 South 13th Avenue

2. City: Laurel 3. State: MS

4. Zip Code: 39440

G. Latitude/Longitude Data

1. Collection Point (check one):

Site Entrance Other: Well head

2. Method of Collection (check one):

GPS Specify coordinate system (NAD 83, etc.)

Map Interpolation (Google Earth, etc.) Other: _____

3. Latitude (degrees/minutes/seconds): 31/50/49.7

4. Longitude (degrees/minutes/seconds): neg 89/18/56.34

5. Elevation (feet): 412

H. SIC Code: 1311

2. Name and Address of Facility Contact

A. Name: Dan Watts Title: EHS Director

B. Mailing Address

1. Street Address or P.O. Box: 140 Mayfair road, Suite 900

2. City: hattiesburg 3. State: MS

4. Zip Code: 39402 5. Fax No.: 601-450-4448

6. Telephone No.: 601-428-2257

7. Email: dwattsl@venture-inc.com

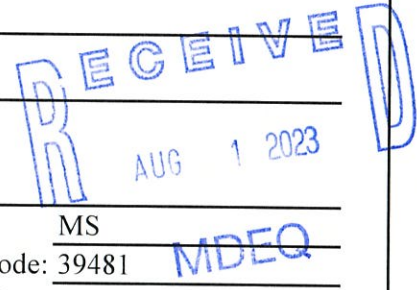

MDEQ NOTICE OF INTENT FOR COVERAGE UNDER THE OIL PRODUCTION GENERAL PERMIT TO CONSTRUCT/OPERATE AIR EMISSIONS EQUIPMENT AT A SYNTHETIC MINOR SOURCE

Facility (Agency Interest) Information

Section OPGP - A

3. Name and Address of Air Contact (if different from Facility Contact)

A. Name: _____ Title: _____

B. Mailing Address

1. Street Address or P.O. Box: _____

2. City: _____ 3. State: _____

4. Zip Code: _____ 5. Fax No.: _____

6. Telephone No.: _____

7. Email: _____

4. Name and Address of Responsible Official for the Facility

The Form must be signed by a Responsible Official as defined in 11 Miss. Admin. Code Pt.2, R. 2.1.C(24).

A. Name: Adam Barham Title: VP-operations

B. Mailing Address

1. Street Address or P.O. Box: 140 Mayfair road, Suite 900

2. City: Hattiesburg 3. State: MS

4. Zip Code: 39402 5. Fax No.: 601-450-4448

6. Telephone No.: 601-518-0622

7. Email: abarham@venture-inc.com

C. Is the person above a duly authorized representative and not a corporate officer?

Yes No

If yes, has written notification of such authorization been submitted to MDEQ?

Yes No Request for authorization is attached

5. Type of Oil Production Notice of Intent (Check all that apply)

Initial Coverage Re-Coverage for existing Coverage

Modification with Public Notice Modification without Public Notice

Update Compliance Plan

MDEQ NOTICE OF INTENT FOR COVERAGE UNDER THE OIL PRODUCTION GENERAL PERMIT TO CONSTRUCT/OPERATE AIR EMISSIONS EQUIPMENT AT A SYNTHETIC MINOR SOURCE

Facility (Agency Interest) Information

Section OPGP - A

6. Equipment List (Check all that apply)

Complete supporting emission calculations must be included for each potential emission unit selected below.

- Heater Treater. Include a completed Section OPGP-C Form for each unit.
- Condensation Storage Vessel. Include a completed Section OPGP-E Form for each unit.
- Water Storage Vessel. Include a completed Section OPGP-E Form for each unit.
- Internal Combustion Engine. Include a completed Section OPGP-D Form for each unit.
- Flare. Include a completed Section OPGP-F Form for each unit.
- Oil Truck Loading (Section OPGP-B Form)
- Component Fugitive Emissions (Section OPGP-B Form)
- Other: _____

7. Process/Product Details

Maximum Anticipated Well(s) Production for Facility:

Produced Material	Throughput	Units
Gas	0.75	MMCF/day
Oil	350	barrels/day
Water	10	barrels/day
Other (Specify)		

Maximum Anticipated Throughput for Principal Product(s) (as applicable):

Produced Material	Throughput	Units
Flared Gas	0.75	MMCF/day
Oil	350	barrels/day
Water	10	barrels/day
Other (Specify)		

8. Zoning

A. Is the facility (either existing or proposed) located in accordance with any applicable city and/or county zoning ordinances? If no, please explain

Yes

B. Is the facility (either existing or proposed) required to obtain any zoning variance to locate/expand the facility at this site? If yes, please explain.

No

C. Is the required USGS quadrangle map or equivalent attached?

Yes No

**MDEQ NOTICE OF INTENT FOR COVERAGE UNDER THE OIL
PRODUCTION GENERAL PERMIT TO CONSTRUCT/OPERATE AIR
EMISSIONS EQUIPMENT AT A SYNTHETIC MINOR SOURCE**

Facility (Agency Interest) Information

Section OPGP - A

9. MS Secretary of State Registration / Certificate of Good Standing

No permit will be issued to a company that is not authorized to conduct business in Mississippi. If the company applying for the permit is a corporation, limited liability company, a partnership or a business trust, the application package should include proof of registration with the Mississippi Secretary of State and/or a copy of the company's Certificate of Good Standing. The name listed on the permit will include the company name as it is registered with the Mississippi Secretary of State.

It should be noted that for an application submitted in accordance with 11 Miss. Admin. Code Pt. 2, R. 2.8.B. to renew a State Permit to Operate or in accordance with 11 Miss. Admin. Code Pt. 2, R. 6.2.A(1)(c). to renew a Title V Permit to be considered timely and complete, the applicant shall be registered and in good standing with the Mississippi Secretary of State to conduct business in Mississippi.

10. Address and Location of Facility Records

Physical Address

1. Street Address:	<u>140 Mayfair Road, Suite 900</u>	
2. City:	<u>Hattiesburg</u>	3. State: <u>MS</u>
4. County:	<u>Forrest</u>	5. Zip Code: <u>39402</u>
6. Telephone No.:	<u>601-518-0622</u>	7. Fax No.: <u>601-450-4448</u>

**MDEQ NOTICE OF INTENT FOR COVERAGE UNDER THE OIL
PRODUCTION GENERAL PERMIT TO CONSTRUCT/OPERATE AIR
EMISSIONS EQUIPMENT AT A SYNTHETIC MINOR SOURCE**

Facility (Agency Interest) Information

Section OPGP - A

11. Certification

*The Form must be signed by a Responsible Official as defined in
11 Miss. Admin. Code Pt. 2, R. 2.1.C.(24).*

*I certify that to the best of my knowledge and belief formed after reasonable inquiry, the
statements and information in this application are true, complete, and accurate, and that as a
responsible official, my signature shall constitute an agreement that the applicant assumes the
responsibility for any alteration, additions, or changes in operation that may be necessary to
achieve and maintain compliance with all applicable Rules and Regulations. I am aware that
there are significant penalties for submitting false information, including the possibility of fine
and imprisonment.*

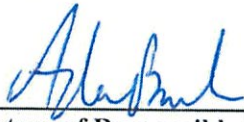

Signature of Responsible Official/DAR



Date

Adam Barham

Printed Name

Date

Section B.1: Maximum Uncontrolled Emissions (under normal operating conditions)

Maximum Uncontrolled Emissions are the emissions at maximum capacity and prior to (in the absence of) pollution control, emission-reducing process equipment, or any other emission reduction. Calculate the hourly emissions using the worst case hourly emissions for each pollutant. For each pollutant, calculate the annual emissions as if the facility were operating at maximum plant capacity without pollution controls for 8760 hours per year, unless otherwise approved by the Department. List Hazardous Air Pollutants (HAP) in Section B.3 and GHGs in Section B.4. Emission Point numbering must be consistent throughout the application package and, for existing emission points, should match any MDEQ ID's in the current permit. Fill all cells in this table with the emission numbers or a "-" symbol. A "-" symbol indicates that emissions of this pollutant are not expected. Emissions > 0.01 TPY must be included. Please do not change the column widths on this table.

Emission Point ID	TSP ¹ (PM)		PM-10 ¹		PM-2.5 ¹		SO ₂		NOx		CO		VOC		TRS ²		Lead		Total HAP's	
	lb/hr	ton/yr	lb/hr	ton/yr	lb/hr	ton/yr	lb/hr	ton/yr	lb/hr	ton/yr	lb/hr	ton/yr	lb/hr	ton/yr	lb/hr	ton/yr	lb/hr	ton/yr	lb/hr	ton/yr
AA-001	0.00	0.00	0.00	0.00	0.00	0.00	0.00	0.00	0.00	0.00	0.00	0.00	500.38	2191.65	0.00	0.00	0.00	0.00	76.7064	335.97
AA-001a	0.00	0.00	0.00	0.00	0.00	0.00	0.00	0.00	0.00	0.00	0.00	0.00	0.00	0.00	0.00	0.00	0.00	0.00	0.0001	0.0004
AA-002	0.01	0.05	0.02	0.10	0.02	0.10	0.00	0.00	2.70	11.83	4.55	19.91	0.04	0.19	0.00	0.00	0.00	0.00	0.0480	0.2103
AA-002a	0.02	0.07	0.03	0.14	0.03	0.14	0.00	0.00	3.52	15.41	5.92	25.94	0.05	0.21	0.00	0.00	0.00	0.00	0.0516	0.2261
AA-003	0.00	0.00	0.00	0.00	0.00	0.00	0.00	0.00	0.00	0.00	0.00	0.00	0.06	0.26	0.00	0.00	0.00	0.00	0.0031	0.0134
AA-004	Routed to AA-001																			
AA-005	Routed to AA-001																			
AA-006	Routed to AA-001																			
AA-006a	0.00	0.00	0.00	0.02	0.00	0.02	0.00	0.00	0.05	0.21	0.04	0.18	0.00	0.01	0.00	0.00	0.00	0.0009	0.0041	
AA-007	0.00	0.00	0.00	0.00	0.00	0.00	0.00	0.00	0.00	0.00	0.00	0.00	0.00	0.02	0.00	0.00	0.00	0.0043	0.0190	
AA-008	Routed to AA-001																			
AA-009	0.00	0.00	0.00	0.00	0.00	0.00	0.00	0.00	0.00	0.00	0.00	0.00	117.72	19.55	0.00	0.00	0.00	5.2676	0.8747	
AA-010	0.00	0.00	0.00	0.02	0.00	0.02	0.00	0.00	0.05	0.21	0.04	0.18	0.00	0.01	0.00	0.00	0.00	0.0009	0.0041	
Totals	0.03	0.13	0.06	0.27	0.06	0.27	0.00	0.01	6.32	27.69	10.55	46.21	618.26	2211.90	0.00	0.00	0.00	82.08	337.33	

¹ Condensables: Include condensable particulate matter emissions in particulate matter calculations for PM-10 and PM-2.5, but not for TSP (PM).

² TRS: Total reduced sulfur (TRS) is the sum of the sulfur compounds hydrogen sulfide (H₂S), methyl mercaptan (CH₃S), dimethyl sulfide (C₂H₆S), and dimethyl disulfide (C₂H₆S₂).

Section B.2: Proposed Allowable Emissions

Proposed Allowable Emissions (Potential to Emit) are those emissions the facility is currently permitted to emit as limited by a specific permit requirement or federal/state standard (e.g., a MACT standard); or the emission rate at which the facility proposes to emit considering emissions control devices, restrictions to operating rates/hours, or other requested permit limits that reduce the maximum emission rates. Emission Point numbering must be consistent throughout the application package and, for existing emission points, should match any MDEQ ID's in the current permit. Fill all cells in this table with the emission numbers or a "-" symbol. A "-" symbol indicates that emissions of this pollutant are not expected. Additional columns may be added if there are regulated pollutants (other than HAPs and GHGs) emitted at the facility.

Emission Point ID	TSP ¹		PM10 ¹		PM2.5 ¹		SO ₂		NOx		CO		VOC		TRS		Lead		
	lb/hr	ton/yr	lb/hr	ton/yr	lb/hr	ton/yr	lb/hr	ton/yr	lb/hr	ton/yr	lb/hr	ton/yr	lb/hr	ton/yr	lb/hr	ton/yr	lb/hr	ton/yr	
AA-001	0.08	0.34	0.31	1.35	0.31	1.35	0.000	0.00	2.81	12.29	12.80	56.04	10.01	43.83	0.00	0.00	0.00	0.00	
AA-001a	0.00	0.00	0.00	0.00	0.00	0.00	0.000	0.00	0.00	0.02	0.00	0.02	0.00	0.00	0.00	0.00	0.00	0.00	
AA-002	0.01	0.05	0.02	0.104	0.02	0.104	0.001	0.004	2.70	11.83	4.55	19.91	0.04	0.19	0.00	0.00	0.00	0.00	
AA-002a	0.02	0.07	0.03	0.135	0.03	0.135	0.001	0.004	3.52	15.41	5.92	25.94	0.05	0.21	0.00	0.00	0.00	0.00	
AA-003	0.00	0.00	0.00	0.00	0.00	0.00	0.00	0.00	0.00	0.00	0.00	0.00	0.06	0.28	0.00	0.00	0.00	0.00	
AA-004	Routed to AA-001																		
AA-005	Routed to AA-001																		
AA-006	Routed to AA-001																		
AA-006a	0.00	0.00	0.00	0.02	0.00	0.02	0.00	0.00	0.05	0.21	0.04	0.18	0.00	0.01	0.00	0.00	0.00	0.00	
AA-007	0.00	0.00	0.00	0.00	0.00	0.00	0.00	0.00	0.00	0.00	0.00	0.00	0.00	0.02	0.00	0.00	0.00	0.00	
AA-008	Routed to AA-001																		
AA-009	0.00	0.00	0.00	0.00	0.00	0.00	0.00	0.00	0.00	0.00	0.00	0.00	117.72	19.55	0.00	0.00	0.00	0.00	
AAA-010	0.00	0.00	0.00	0.02	0.00	0.02	0.00	0.00	0.05	0.21	0.04	0.18	0.00	0.01	0.00	0.00	0.00	0.00	
Totals	0.11	0.46	0.37	1.62	0.37	1.62	0.00	0.01	9.13	39.98	23.35	95.00	127.89	64.10	0.00	0.00	0.00	0.00	

¹ Condensables: Include condensable particulate matter emissions in particulate matter calculations for PM-10 and PM-2.5, but not for TSP (PM).

² TRS: Total reduced sulfur (TRS) is the sum of the sulfur compounds hydrogen sulfide (H₂S), methyl mercaptan (CH₃S), dimethyl sulfide (C₂H₆S), and dimethyl disulfide (C₂H₆S₂).

Section B.3: Proposed Allowable Hazardous Air Pollutants (HAPs)

In the table below, report the Proposed Allowable Emissions (Potential to Emit) for each HAP from each regulated emission unit if the HAP > 0.0001 tpy. Each facility-wide Individual HAP total and the facility-wide Total HAPs shall be the sum of all HAP sources. Use the HAP nomenclature as it appears in the Instructions. Emission Point numbering must be consistent throughout the application package and, for existing emission points, should match any MDEQ ID's in the current permit. For each HAP listed, fill all cells in this table with the emission numbers or a "-" symbol. A "-" symbol indicates that emissions of this pollutant are not expected or the pollutant is emitted in a quantity less than the threshold amounts described above. Additional columns may be added as necessary to address each HAP.

Emission Point ID	Total HAPs		1,1,2,2-tetrachloroethane		1,1,2,2-trichloroethane		1,3-butadiene		1,3-dichloropropene		acetaldehyde		acrolein		benzene		carbon tetrachloride	
	lb/hr	ton/yr	lb/hr	ton/yr	lb/hr	ton/yr	lb/hr	ton/yr	lb/hr	ton/yr	lb/hr	ton/yr	lb/hr	ton/yr	lb/hr	ton/yr	lb/hr	ton/yr
AA-001	1.5341	6.7195	<0.0001	<0.0001	<0.0001	<0.0001	<0.0001	<0.0001	<0.0001	<0.0001	<0.0001	<0.0001	<0.0001	<0.0001	0.0326	0.1426	<0.0001	<0.0001
AA-001a	0.0001	0.0004	<0.0001	<0.0001	<0.0001	<0.0001	<0.0001	<0.0001	<0.0001	<0.0001	<0.0001	<0.0001	<0.0001	<0.0001	<0.0001	<0.0001	<0.0001	<0.0001
AA-002	0.0396	0.1735	<0.0001	0.0001	0.0001	0.0001	0.0008	0.0035	<0.0001	0.0001	0.0034	0.0149	0.0032	0.0141	0.0019	0.0085	<0.0001	0.0001
AA-002a	0.0516	0.2261	<0.0001	0.0002	<0.0001	0.0001	0.0011	0.0046	<0.0001	0.0001	0.0044	0.0195	0.0042	0.0183	0.0025	0.0110	<0.0001	0.0001
AA-003	0.0036	0.0134	<0.0001	<0.0001	<0.0001	<0.0001	<0.0001	<0.0001	<0.0001	<0.0001	<0.0001	<0.0001	<0.0001	<0.0001	0.0002	0.0010	<0.0001	<0.0001
AA-004	Routed to AA-001																	
AA-005	Routed to AA-001																	
AA-006	Routed to AA-001																	
AA-006a	0.0009	0.0041	<0.0001	<0.0001	<0.0001	<0.0001	<0.0001	<0.0001	<0.0001	<0.0001	<0.0001	<0.0001	<0.0001	<0.0001	<0.0001	<0.0001	<0.0001	<0.0001
AA-007	0.0043	0.0190	<0.0001	<0.0001	<0.0001	<0.0001	<0.0001	<0.0001	<0.0001	<0.0001	<0.0001	<0.0001	<0.0001	<0.0001	<0.0001	<0.0001	<0.0001	<0.0001
AA-008	Routed to AA-001																	
AA-009	5.2676	0.8747	<0.0001	<0.0001	<0.0001	<0.0001	<0.0001	<0.0001	<0.0001	<0.0001	<0.0001	<0.0001	<0.0001	<0.0001	0.5648	0.0938	<0.0001	<0.0001
AA-010	0.00093	0.00409	<0.0001	<0.0001	<0.0001	<0.0001	<0.0001	<0.0001	<0.0001	<0.0001	<0.0001	<0.0001	<0.0001	<0.0001	<0.0001	<0.0001	<0.0001	<0.0001
Totals:	6.9029	8.0347	0.0000	0.0003	0.0000	0.0002	0.0019	0.0082	0.0000	0.0002	0.0079	0.0344	0.0074	0.0324	0.6021	0.2569	0.0000	0.0002

Section B.3: Proposed Allowable Hazardous Air Pollutants (HAPs)

In the table below, report the Proposed Allowable Emissions (Potential to Emit) for each HAP from each regulated emission unit if the HAP > 0.0001 tpy. Each facility-wide Individual HAP total and the facility-wide Total HAPs shall be the sum of all HAP sources. Use the HAP nomenclature as it appears in the Instructions. Emission Point numbering must be consistent throughout the application package and, for existing emission points, should match any MDEQ ID's in the current permit. For each HAP listed, fill all cells in this table with the emission numbers or a "-" symbol. A "-" symbol indicates that emissions of this pollutant are not expected or the pollutant is emitted in a quantity less than the threshold amounts described above. Additional columns may be added as necessary to address each HAP.

Emission Point ID	Total HAPs		chlorobenzene		chloroform		ethylbenzene		ethylene dibromide		formaldehyde		methanol		methylene chloride		naphthalene	
	lb/hr	ton/yr	lb/hr	ton/yr	lb/hr	ton/yr	lb/hr	ton/yr	lb/hr	ton/yr	lb/hr	ton/yr	lb/hr	ton/yr	lb/hr	ton/yr	lb/hr	ton/yr
AA-001	0.1414	6.7195	<0.0001	<0.0001	<0.0001	<0.0001	0.0022	0.0096	<0.0001	<0.0001	<0.0001	<0.0001	<0.0001	<0.0001	<0.0001	<0.0001	<0.0001	<0.0001
AA-001a	0.0001	0.0004	<0.0001	<0.0001	<0.0001	<0.0001	<0.0001	<0.0001	<0.0001	<0.0001	<0.0001	<0.0001	<0.0001	<0.0001	<0.0001	<0.0001	<0.0001	<0.0001
AA-002	0.0396	0.1735	<0.0001	0.0001	<0.0001	0.0001	<0.0001	0.0001	<0.0001	<0.0001	0.1097	0.0037	0.0164	0.0001	0.0002	0.0001	0.0005	0.0005
AA-002a	0.0227	0.2261	<0.0001	<0.0001	<0.0001	<0.0001	<0.0001	0.0002	<0.0001	<0.0001	0.0326	0.0049	0.0213	<0.0001	0.0003	0.0002	0.0007	0.0007
AA-003	0.0031	0.0134	<0.0001	<0.0001	<0.0001	<0.0001	<0.0001	0.0001	<0.0001	<0.0001	<0.0001	<0.0001	<0.0001	<0.0001	<0.0001	<0.0001	<0.0001	<0.0001
AA-004	Routed to AA-001																	
AA-005	Routed to AA-001																	
AA-006	Routed to AA-001																	
AA-006a	0.0009	0.0041	<0.0001	<0.0001	<0.0001	<0.0001	<0.0001	<0.0001	<0.0001	<0.0001	0.0002	<0.0001	<0.0001	<0.0001	<0.0001	<0.0001	<0.0001	<0.0001
AA-007	0.0043	0.0190	<0.0001	<0.0001	<0.0001	<0.0001	<0.0001	<0.0001	<0.0001	<0.0001	<0.0001	<0.0001	<0.0001	<0.0001	<0.0001	<0.0001	<0.0001	<0.0001
AA-008	Routed to AA-001																	
AA-009	5.2676	0.8747	<0.0001	<0.0001	<0.0001	<0.0001	0.0216	0.0036	<0.0001	<0.0001	<0.0001	<0.0001	<0.0001	<0.0001	<0.0001	<0.0001	<0.0001	<0.0001
AA-010	0.0009	0.0041	<0.0001	<0.0001	<0.0001	<0.0001	<0.0001	<0.0001	<0.0001	<0.0001	0.0002	<0.0001	<0.0001	<0.0001	<0.0001	<0.0001	<0.0001	<0.0001
Totals:	5.4806	8.0347	0.0000	0.0001	0.0000	0.0001	0.0237	0.0135	0.0000	0.0003	0.0577	0.2530	0.0086	0.0377	0.0001	0.0005	0.0003	0.0012

Section B.3: Proposed Allowable Hazardous Air Pollutants (HAPs)

In the table below, report the Proposed Allowable Emissions (Potential to Emit) for each HAP from each regulated emission unit if the HAP > 0.0001 tpy. Each facility-wide Individual HAP total and the facility-wide Total HAPs shall be the sum of all HAP sources. Use the HAP nomenclature as it appears in the Instructions. Emission Point numbering must be consistent throughout the application package and, for existing emission points, should match any MDEQ ID's in the current permit. For each HAP listed, fill all cells in this table with the emission numbers or a "-" symbol. A "-" symbol indicates that emissions of this pollutant are not expected or the pollutant is emitted in a quantity less than the threshold amounts described above. Additional columns may be added as necessary to address each HAP.

Emission Point ID	Total HAPs		PAH		styrene		toluene		vinyl chloride		xylene		hexane		POM	
	lb/hr	ton/yr	lb/hr	ton/yr	lb/hr	ton/yr	lb/hr	ton/yr	lb/hr	ton/yr	lb/hr	ton/yr	lb/hr	ton/yr	lb/hr	ton/yr
AA-001	0.1414	6.7195	<0.0001	<0.0001	<0.0001	<0.0001	0.0306	0.1342	<0.0001	<0.0001	0.0176	0.0769	1.4512	6.3562	<0.0001	<0.0001
AA-001a	0.0001	0.0004	<0.0001	<0.0001	<0.0001	<0.0001	<0.0001	<0.0001	<0.0001	<0.0001	<0.0001	<0.0001	0.0001	0.0004	<0.0001	<0.0001
AA-002	0.0396	0.1735	0.0002	0.0008	<0.0001	0.0001	0.0007	0.0030	<0.0001	<0.0001	0.0002	0.0010	<0.0001	<0.0001	<0.0001	<0.0001
AA-002a	0.0227	0.2261	0.0002	0.0010	<0.0001	<0.0001	0.0009	0.0039	<0.0001	<0.0001	0.0003	0.0014	<0.0001	<0.0001	<0.0001	<0.0001
AA-003	0.0031	0.0134	<0.0001	<0.0001	<0.0001	<0.0001	0.0002	0.0008	<0.0001	<0.0001	0.0001	0.0004	0.0169	0.0742	<0.0001	<0.0001
AA-004	Routed to AA-001															
AA-005	Routed to AA-001															
AA-006	Routed to AA-001															
AA-006a	0.0009	0.0041	<0.0001	<0.0001	<0.0001	<0.0001	<0.0001	<0.0001	<0.0001	<0.0001	<0.0001	<0.0001	0.0009	0.0039	<0.0001	0.0001
AA-007	0.0043	0.0190	<0.0001	<0.0001	<0.0001	<0.0001	<0.0001	<0.0001	<0.0001	<0.0001	<0.0001	<0.0001	<0.0001	<0.0001	<0.0001	<0.0001
AA-008	Routed to AA-001															
AA-009	<0.0001	0.8747	<0.0001	<0.0001	<0.0001	<0.0001	0.5593	0.0929	<0.0001	<0.0001	0.2946	0.0489	3.8273	0.6356	<0.0001	<0.0001
AA-010	0.00093	0.00409	<0.0001	<0.0001	<0.0001	<0.0001	<0.0001	<0.0001	<0.0001	<0.0001	<0.0001	<0.0001	0.00088	0.00386	<0.0001	0.0001
Totals:	0.2130	8.0347	0.0004	0.0017	0.0000	0.0001	0.5917	0.2347	0.0000	0.0000	0.3128	0.1287	5.2973	7.0741	0.0000	0.0001

Section B.4: Greenhouse Gas Emissions

Applicants must report potential emission rates in SHORT TONS per year, as opposed to metric tons required by Part 98. Emission Point numbering must be consistent throughout the application package and, for existing emission points, should match any MDEQ ID's in the current permit.

Emission Point ID	GWPs ¹	CO ₂ (non-biogenic) ton/yr	CO ₂ (biogenic) ² ton/yr	N ₂ O ton/yr	CH ₄ ton/yr	SF ₆ ton/yr	PFC/HFC ³ ton/yr	Total GHG Mass Basis ton/yr ⁵	Total CO ₂ e ton/yr ⁶
AA-001	mass GHG	22362.21	0	0.04	91.78	0	0	22454.03	N/A
	CO ₂ e	22362.21	0	11.46	2294.46	0	0	N/A	24668.14
AA-001a	mass GHG	25.59	0	0.00	0.00	0	0	25.59	N/A
	CO ₂ e	25.59	0	0.01	0.01	0	0	N/A	25.62
AA-002	mass GHG	624.23	0	0.00	0.01	0	0	624.24	N/A
	CO ₂ e	624.23	0	0.35	0.29	0	0	N/A	624.88
AA-002a	mass GHG	813.39	0	0.00	0.02	0	0	813.41	N/A
	CO ₂ e	813.39	0	0.46	0.38	0	0	N/A	814.23
AA-003	mass GHG	0.03	0	0.00	0.32	0	0	0.35	N/A
	CO ₂ e	0.03	0	0.00	7.97	0	0	N/A	8.00
AA-004	mass GHG	0	0	0	0	0	0	0.00	N/A
	CO ₂ e	0	0	0	0	0	0	N/A	0.00
AA-005	mass GHG	0	0	0	0	0	0	0.00	N/A
	CO ₂ e	0	0	0	0	0	0	N/A	0.00
AA-006	mass GHG	0	0	0	0	0	0	0.00	N/A
	CO ₂ e	0	0	0	0	0	0	N/A	0.00
AA-006a	mass GHG	255.45	0	0.00	0.00	0	0	255.46	N/A
	CO ₂ e	255.45	0	0.14	0.12	0	0	N/A	255.71
AA-007	mass GHG	0	0	0	0	0	0	0.00	N/A
	CO ₂ e	0	0	0	0	0	0	N/A	0.00
AA-008	mass GHG	0	0	0	0	0	0	0.00	N/A
	CO ₂ e	0	0	0	0	0	0	N/A	0.00
AA-009	mass GHG	0.03	0	0	0.18	0	0	0.21	N/A
	CO ₂ e	0.03	0	0	4.50	0	0	N/A	4.53
AA-010	mass GHG	255.45	0	0.00	0.00	0	0	255.46	N/A
	CO ₂ e	255.45	0	0.14	0.12	0	0	N/A	255.71
FACILITY TOTAL	mass GHG	24336.39	0	0.50	92.68	0.00	0.00	24428.74	N/A
	CO ₂ e	24336.39	0	12.57	2307.86	0.00	0.00	N/A	26656.82

¹ GWP (Global Warming Potential): Applicants must use the most current GWPs codified in Table A-1 of 40 CFR part 98. GWPs are subject to change, therefore, applicants need to check 40 CFR 98 to confirm GWP values.

² Biogenic CO₂ is defined as carbon dioxide emissions resulting from the combustion or decomposition of non-fossilized and biodegradable organic material originating from plants, animals, or micro-organisms.

³ For HFCs or PFCs describe the specific HFC or PFC compound and use a separate column for each individual compound.

⁴ For each new compound, enter the appropriate GWP for each HFC or PFC compound from Table A-1 in 40 CFR 98.

⁵ Greenhouse gas emissions on a mass basis is the ton per year greenhouse gas emission before adjustment with its GWP. Do not include biogenic CO₂ in this total.

⁶ CO₂e means Carbon Dioxide Equivalent and is calculated by multiplying the TPY mass emissions of the greenhouse gas by its GWP. Do not include biogenic CO₂e in this total.

Section B.5: Stack Parameters and Exit Conditions

Emission Point numbering must be consistent throughout the application package and, for existing emission points, should match any MDEQ ID's in the current permit.

Emission Point ID	Orientation (H=Horizontal V=Vertical)	Rain Caps (Yes or No)	Height Above Ground (ft)	Base Elevation (ft)	Exit Temp. (°F)	Inside Diameter or Dimensions (ft)	Velocity (ft/sec)	Moisture by Volume (%)	Geographic Position (degrees/minutes/seconds)	
									Latitude	Longitude
AA-001	H	No	40	415	1800	0.50	100	TBD	31/50/50	89/18/56
AA-002	H	Yes	7	415	TBD	TBD	TBD	TBD	31/50/50	89/18/56
AA-002a	H	yes	7	415	TBD	TBD	TBD	TBD	31/50/50	89/18/56
AA-003	N/A-Fugitives	N/A	N/A	415	N/A	N/A	N/A	N/A	31/50/50	89/18/56
AA-004	N/A-Separator	N/A	N/A	415	N/A	N/A	N/A	N/A	31/50/50	89/18/56
AA-005	N/A-Separator	N/A	N/A	415	N/A	N/A	N/A	N/A	31/50/50	89/18/56
AA-006	N/A-Heater Treater	N/A	N/A	415	N/A	N/A	N/A	N/A	31/50/50	89/18/56
AA-006a	TBD	TBD	TBD	415	TBD	TBD	TBD	TBD	31/50/50	89/18/56
AA-007	N/A-Tanks	N/A	N/A	415	N/A	N/A	N/A	N/A	31/50/50	89/18/56
AA-008	N/A-Tanks	N/A	N/A	415	N/A	N/A	N/A	N/A	31/50/50	89/18/56
AA-009	N/A-Truck Loading	N/A	N/A	415	N/A	N/A	N/A	N/A	31/50/50	89/18/56
AA-010	Line heater	N/A	N/A	415	N/A	N/A	N/A	N/A	31/50/50	89/18/56

¹ A WAAS-capable GPS receiver should be used and in the WGS84 or NAD83 coordinate system.

MDEQ NOTICE OF INTENT FOR COVERAGE UNDER THE OIL PRODUCTION GENERAL PERMIT TO CONSTRUCT/OPERATE AIR EMISSIONS EQUIPMENT AT A SYNTHETIC MINOR SOURCE

Fuel Burning Equipment – External Combustion Sources

Section OPGP-C

1. Emission Point Description

- A. Emission Point Designation (Ref. No.): AA-010
- B. Equipment Description: Line heater
- C. Manufacturer: custom D. Date of Manufacture and No.: 2020
- E. Maximum Heat Input (higher heating value): 050 MMBtu/hr F. Nominal Heat Input Capacity: 0.50 MMBtu/hr
- G. Use: Line Heater Heater Treater TEG Burner
 Space Heat Process Heat Other (describe): _____
- H. Heat Mechanism: Direct Indirect
- I. Burner Type (e.g., forced draft, natural draft, etc.): Natural draft
- J. Additional Design Controls (e.g., FGR, etc.): none
- K. Status: Operating Proposed Under Construction

2. Fuel Type

Complete the following table, identifying each type of fuel and the amount used. Specify the units for heat content, hourly usage, and yearly usage.

FUEL TYPE	HEAT CONTENT	% SULFUR	% ASH	MAXIMUM HOURLY USAGE	MAXIMUM YEARLY USAGE
Field gas	1000	<0.001	<0.001	500	4.38 MMCF

Please list any fuel components that are hazardous air pollutants and the percentage in the fuel:

MDEQ NOTICE OF INTENT FOR COVERAGE UNDER THE OIL PRODUCTION GENERAL PERMIT TO CONSTRUCT/OPERATE AIR EMISSIONS EQUIPMENT AT A SYNTHETIC MINOR SOURCE

Fuel Burning Equipment – External Combustion Sources

Section OPGP-C

1. Emission Point Description

- A. Emission Point Designation (Ref. No.): AA-006A
- B. Equipment Description: One (1) Heater Treater, with a 0.5 MMBTUH burner.
- C. Manufacturer: Custom D. Date of Manufacture and No.: 2019
- E. Maximum Heat Input (higher heating value): 0.5 MMBtu/hr F. Nominal Heat Input Capacity: 0.5 MMBtu/hr
- G. Use: Line Heater Heater Treater TEG Burner
 Space Heat Process Heat Other (describe): _____
- H. Heat Mechanism: Direct Indirect
- I. Burner Type (e.g., forced draft, natural draft, etc.): Forced Draft
- J. Additional Design Controls (e.g., FGR, etc.): N/A
- K. Status: Operating Proposed Under Construction

2. Fuel Type

Complete the following table, identifying each type of fuel and the amount used. Specify the units for heat content, hourly usage, and yearly usage.

FUEL TYPE	HEAT CONTENT	% SULFUR	% ASH	MAXIMUM HOURLY USAGE	MAXIMUM YEARLY USAGE
Field Gas	1,000 BTU/CF	< 0.001	< 0.001	490	4.3 MMCF

Please list any fuel components that are hazardous air pollutants and the percentage in the fuel:
No analyzed HAP's have been identified as components in the fuel; however, AP-42, Tables 1.4-2, 1.4-3, and 1.4-4 project certain HAP's to be potentially present in exhaust vapors.

MDEQ NOTICE OF INTENT FOR COVERAGE UNDER THE OIL PRODUCTION GENERAL PERMIT TO CONSTRUCT/OPERATE AIR EMISSIONS EQUIPMENT AT A SYNTHETIC MINOR SOURCE

Fuel Burning Equipment – Internal Combustion Engines

Section OPGP- D

1. Emission Point Description

- A. Emission Point Designation (Ref. No.): AA-002
- B. Equipment Description (including serial number): 165 HP RICE for power oil pump
- C. Manufacturer: TBD D. Date of Manufacture and Model No.: Pre-2006
- E. Maximum Heat Input (higher heating value): 1.22 MMBtu/hr
- F. Rated Power: 165 hp 123 kW
- G. Is the engine an EPA-certified engine? No Yes or No
- H. Use: Non-emergency Emergency
- I. Displacement per cylinder: < 10 Liters 10 to <30 Liters ≥ 30 Liters
- J. Engine Ignition Type: Spark Ignition Compression Ignition
- K. Engine Burn Type: 4-stroke 2-stroke Rich Burn Lean Burn
(check all that apply)
- L. Status: Operating Proposed Under Construction
- M. Date of construction, reconstruction, or most recent modification (for existing sources) or date of anticipated construction: Pre-2006

2. Fuel Type

Complete the following table, identifying each type of fuel and the amount used. Specify units of measurement.

FUEL TYPE	HEAT CONTENT	% SULFUR	% ASH	MAXIMUM HOURLY USAGE	MAXIMUM YEARLY USAGE
Nat. Gas/propane	1020 BTU/Ft3	0.00004	0.0	1.20 MCF	10,478

MDEQ NOTICE OF INTENT FOR COVERAGE UNDER THE OIL PRODUCTION GENERAL PERMIT TO CONSTRUCT/OPERATE AIR EMISSIONS EQUIPMENT AT A SYNTHETIC MINOR SOURCE

Fuel Burning Equipment – Internal Combustion Engines

Section OPGP- D

1. Emission Point Description

- A. Emission Point Designation (Ref. No.): AA-002a
- B. Equipment Description (including serial number): 215 HP RICE for sales gas compressor
- C. Manufacturer: TBD D. Date of Manufacture and Model No.: Pre- 2006
- E. Maximum Heat Input (higher heating value): 1.59 MMBtu/hr
- F. Rated Power: 215 hp 162 kW
- G. Is the engine an EPA-certified engine? No Yes or No
- H. Use: Non-emergency Emergency
- I. Displacement per cylinder: < 10 Liters 10 to <30 Liters ≥ 30 Liters
- J. Engine Ignition Type: Spark Ignition Compression Ignition
- K. Engine Burn Type: 4-stroke 2-stroke Rich Burn Lean Burn
(check all that apply)
- L. Status: Operating Proposed Under Construction
- M. Date of construction, reconstruction, or most recent modification (for existing sources) or date of anticipated construction: Pre- 2006

2. Fuel Type

Complete the following table, identifying each type of fuel and the amount used. Specify units of measurement.

FUEL TYPE	HEAT CONTENT	% SULFUR	% ASH	MAXIMUM HOURLY USAGE	MAXIMUM YEARLY USAGE
Nat. Gas/propane	1020 BTU/Ft3	0.00004	0.0	1.59 MCF	13.93 MMCF

MDEQ NOTICE OF INTENT FOR COVERAGE UNDER THE OIL PRODUCTION GENERAL PERMIT TO CONSTRUCT/OPERATE AIR EMISSIONS EQUIPMENT AT A SYNTHETIC MINOR SOURCE

Tank Summary

Section OPGP-E

1. Emission Point Description

- A. Emission Point Designation (Ref. No.): AA-008 (Power Oil Tank No. 1)
- B. Product(s) Stored: Oil
- C. Status: Operating Proposed Under Construction
- D. Date of construction, reconstruction, or most recent modification (for existing sources) or date of anticipated construction: 2021

2. Tank Data

- A. Tank Specifications:
- | | | | |
|---|---------------|----------|-------------------|
| 1. Design capacity | <u>21,000</u> | gallons | |
| 2. True vapor pressure at storage temperature: | <u>11.55</u> | psia @ | <u>ambient</u> °F |
| 3. Maximum true vapor pressure (as defined in §60.111b) | <u>11.55</u> | psia @ | <u>ambient</u> °F |
| 4. Reid vapor pressure at storage temperature: | <u>11.55</u> | psia @ | <u>ambient</u> °F |
| 5. Density of product at storage temperature: | <u>7.2</u> | lb/gal | |
| 6. Molecular weight of product vapor at storage temp. | <u>48</u> | lb/lbmol | |
- B. Tank Orientation: Vertical Horizontal
- C. Type of Tank:
- Fixed Roof External Floating Roof Internal Floating Roof
- Pressure Variable Vapor Space Other: _____
- D. Is the tank equipped with a Vapor Recovery System and/or flare? Yes No
- If yes, describe below and include the efficiency of each.*
The tanks will be vented to the flare. If a VRU is necessary, it will be installed.
- E. Closest City:
- Jackson, MS Meridian, MS Tupelo, MS Mobile, AL
- New Orleans, LA Memphis, TN Baton Rouge, LA
- F. Is an E&P or similar report described in Condition 5.4(5) of the General Permit included for this tank in the Notice of Intent? Yes No

Tank Summary

Section H

3. Horizontal Fixed Roof Tank

- A. Shell Length: _____ feet
 B. Shell Diameter: _____ feet
 C. Working Volume: _____ gal
 D. Maximum Throughput: _____ gal/yr
 E. Is the tank heated? Yes No
 F. Is the tank underground? Yes No
 G. Shell Color/Shade:
 Aluminum/Specular Aluminum/Diffuse
 Gray/Light Gray/Medium Red/Primer
 H. Shell Condition: Good Poor

4. Vertical Fixed Roof Tank

- A. Dimensions:
 1. Shell Height: _____ 25 _____ feet
 2. Shell Diameter: _____ 12 _____ feet
 3. Maximum Liquid Height: _____ 24.8 _____ feet
 4. Average Liquid Height: _____ 18 _____ feet
 5. Working Volume: _____ 21,000 _____ gal
 6. Turnovers per year: _____ 159.1 _____
 7. Maximum throughput: _____ 3,340,554 _____ gal/yr
 8. Is the tank heated? Yes No
- B. Shell Characteristics:
 1. Shell Color/Shade:
 White/White Aluminum/Specular Aluminum/Diffuse
 Gray/Light Gray/Medium Red/Primer
 2. Shell Condition: Good Poor
- C. Roof Characteristics:
 1. Roof Color/Shade:
 White/White Aluminum/Specular Aluminum/Diffuse
 Gray/Light Gray/Medium Red/Primer
 2. Roof Condition: Good Poor
 3. Type: Cone Dome
 4. Height: _____ 0.1 _____ feet

Tank Summary	Section H
---------------------	------------------

5. Internal Floating Roof Tank

- A. Tank Characteristics:
1. Diameter: _____ feet
 2. Tank Volume: _____ gal
 3. Turnovers per year: _____
 4. Maximum Throughput: _____ gal/yr
 5. Number of Columns: _____
 6. Self-Supporting Roof? Yes No
 7. Effective Column Diameter:

<input type="checkbox"/> 9"x7" Built-up Column	<input type="checkbox"/> 8" Diameter Pipe	<input type="checkbox"/> Unknown
--	---	----------------------------------
 8. Internal Shell Condition:

<input type="checkbox"/> Light Rust	<input type="checkbox"/> Dense Rust	<input type="checkbox"/> Gunite Lining
-------------------------------------	-------------------------------------	--
 9. External Shell Color/Shade:

<input type="checkbox"/> White/White	<input type="checkbox"/> Aluminum/Specular	<input type="checkbox"/> Aluminum/Diffuse
<input type="checkbox"/> Gray/Light	<input type="checkbox"/> Gray/Medium	<input type="checkbox"/> Red/Primer
 10. External Shell Condition: Good Poor
 11. Roof Color/Shade:

<input type="checkbox"/> White/White	<input type="checkbox"/> Aluminum/Specular	<input type="checkbox"/> Aluminum/Diffuse
<input type="checkbox"/> Gray/Light	<input type="checkbox"/> Gray/Medium	<input type="checkbox"/> Red/Primer
 12. Roof Condition: Good Poor
- B. Rim Seal System:
1. Primary Seal: Mechanical Shoe Liquid-mounted Vapor-mounted
 2. Secondary Seal: Shoe-mounted Rim-mounted None
- C. Deck Characteristics:
1. Deck Type: Bolted Welded
 2. Deck Fitting Category: Typical Detail

6. External Floating Roof Tank

- A. Tank Characteristics
1. Diameter: _____ feet
 2. Tank Volume: _____ gal
 3. Turnovers per year: _____
 4. Maximum Throughput: _____ gal/yr
 5. Internal Shell Condition:

<input type="checkbox"/> Light Rust	<input type="checkbox"/> Dense Rust	<input type="checkbox"/> Gunite Lining
-------------------------------------	-------------------------------------	--

Tank Summary	Section H
---------------------	------------------

6. External Floating Roof Tank (continued)

- A. Tank Characteristics (continued):
6. Paint Color/Shade:
- | | | |
|--------------------------------------|--|---|
| <input type="checkbox"/> White/White | <input type="checkbox"/> Aluminum/Specular | <input type="checkbox"/> Aluminum/Diffuse |
| <input type="checkbox"/> Gray/Light | <input type="checkbox"/> Gray/Medium | <input type="checkbox"/> Red/Primer |
7. Paint Condition: Good Poor
- B. Roof Characteristics
1. Roof Type: Pontoon Double Deck
2. Roof Fitting Category: Typical Detail
- C. Tank Construction and Rim-Seal System:
1. Tank Construction: Welded Riveted
2. Primary Seal:
- | | | |
|--|---|--|
| <input type="checkbox"/> Mechanical Shoe | <input type="checkbox"/> Liquid-mounted | <input type="checkbox"/> Vapor-mounted |
|--|---|--|
3. Secondary Seal
- | | | | |
|-------------------------------|---------------------------------------|--------------------------------------|---|
| <input type="checkbox"/> None | <input type="checkbox"/> Shoe-mounted | <input type="checkbox"/> Rim-mounted | <input type="checkbox"/> Weather shield |
|-------------------------------|---------------------------------------|--------------------------------------|---|

7. Pollutant Emissions

A. Fixed Roof Emissions:

Pollutant ¹	Working Loss (tons/yr)	Breathing Loss (tons/yr)	Total Emissions (tons/yr)*
VOC		Total W&B 0.91	30.96
Hexane		0.1439	2.8191
Benzene		0.0355	0.6979
Ethylbenzene		0.0005	0.0102
Toluene		0.0201	0.3890
Xylene		0.0118	0.2248

B. Floating Roof Emissions:

Pollutant ¹	Rim Seal Loss (tons/yr)	Withdrawal Loss (tons/yr)	Deck Fitting Loss (tons/yr)	Deck Seam Loss (tons/yr)	Landing Loss ² (tons/yr)	Total Emissions (tons/yr)

*** Total emissions in Table 7A are the sum of flash emissions and working and breathing emissions**

1. All regulated air pollutants including hazardous air pollutants emitted from this source should be listed in accordance with the Permit Application Instructions. A list of regulated air pollutants and hazardous air pollutants is provided in the Application Instructions.

2. Landing losses should be determined according to the procedures in *Organic Liquid Storage Tanks* chapter of EPA's AP-42 emission factors. If the roof is not landed at least once/yr, enter "NA".

MDEQ NOTICE OF INTENT FOR COVERAGE UNDER THE OIL PRODUCTION GENERAL PERMIT TO CONSTRUCT/OPERATE AIR EMISSIONS EQUIPMENT AT A SYNTHETIC MINOR SOURCE

Tank Summary

Section OPGP-E

1. Emission Point Description

- A. Emission Point Designation (Ref. No.): AA-008 (Oil Storage Tank No. 2)
- B. Product(s) Stored: Oil
- C. Status: Operating Proposed Under Construction
- D. Date of construction, reconstruction, or most recent modification (for existing sources) or date of anticipated construction: 2021

2. Tank Data

- A. Tank Specifications:
- | | | | |
|---|---------------|----------|-------------------|
| 1. Design capacity | <u>16,800</u> | gallons | |
| 2. True vapor pressure at storage temperature: | <u>11.55</u> | psia @ | <u>ambient</u> °F |
| 3. Maximum true vapor pressure (as defined in §60.111b) | <u>11.55</u> | psia @ | <u>ambient</u> °F |
| 4. Reid vapor pressure at storage temperature: | <u>11.55</u> | psia @ | <u>ambient</u> °F |
| 5. Density of product at storage temperature: | <u>7.2</u> | lb/gal | |
| 6. Molecular weight of product vapor at storage temp. | <u>48</u> | lb/lbmol | |
- B. Tank Orientation: Vertical Horizontal
- C. Type of Tank:
- Fixed Roof External Floating Roof Internal Floating Roof
- Pressure Variable Vapor Space Other: _____
- D. Is the tank equipped with a Vapor Recovery System and/or flare? Yes No
- If yes, describe below and include the efficiency of each.*
The tanks will be vented to the flare. If a VRU is necessary, it will be installed.
- E. Closest City:
- Jackson, MS Meridian, MS Tupelo, MS Mobile, AL
- New Orleans, LA Memphis, TN Baton Rouge, LA
- F. Is an E&P or similar report described in Condition 5.4(5) of the General Permit included for this tank in the Notice of Intent? Yes No

MDEQ NOTICE OF INTENT FOR COVERAGE UNDER THE OIL PRODUCTION GENERAL PERMIT TO CONSTRUCT/OPERATE AIR EMISSIONS EQUIPMENT AT A SYNTHETIC MINOR SOURCE

Tank Summary

Section OPGP-E

3. Horizontal Fixed Roof Tank

- A. Shell Length: _____ feet
 B. Shell Diameter: _____ feet
 C. Working Volume: _____ gal
 D. Maximum Throughput: _____ gal/yr
 E. Is the tank heated? Yes No
 F. Is the tank underground? Yes No
 G. Shell Color/Shade:
 Aluminum/Specular Aluminum/Diffuse
 Gray/Light Gray/Medium Red/Primer
 H. Shell Condition: Good Poor

4. Vertical Fixed Roof Tank

- A. Dimensions:
 1. Shell Height: _____ 20 _____ feet
 2. Shell Diameter: _____ 12 _____ feet
 3. Maximum Liquid Height: _____ 19 _____ feet
 4. Average Liquid Height: _____ ~10 _____ feet
 5. Working Volume: _____ 16,800 _____ gal
 6. Turnovers per year: _____ 91.25 _____ (est. for each oil storage tank)
 7. Maximum throughput: _____ 3.066 _____ MMgal/yr (for entire tank battery)
 8. Is the tank heated? Yes No
- B. Shell Characteristics:
 1. Shell Color/Shade:
 White/White Aluminum/Specular Aluminum/Diffuse
 Gray/Light Gray/Medium Red/Primer
 2. Shell Condition: Good Poor
- C. Roof Characteristics:
 1. Roof Color/Shade:
 White/White Aluminum/Specular Aluminum/Diffuse
 Gray/Light Gray/Medium Red/Primer
 2. Roof Condition: Good Poor
 3. Type: Cone Dome
 4. Height: _____ 1 _____ feet

MDEQ NOTICE OF INTENT FOR COVERAGE UNDER THE OIL PRODUCTION GENERAL PERMIT TO CONSTRUCT/OPERATE AIR EMISSIONS EQUIPMENT AT A SYNTHETIC MINOR SOURCE

Tank Summary

Section OPGP-E

5. Internal Floating Roof Tank

A. Tank Characteristics:

1. Diameter: _____ feet
2. Tank Volume: _____ gal
3. Turnovers per year: _____
4. Maximum Throughput: _____ gal/yr
5. Number of Columns: _____
6. Self-Supporting Roof? Yes No
7. Effective Column Diameter:
 - 9"x7" Built-up Column
 - 8" Diameter Pipe
 - Unknown
8. Internal Shell Condition:
 - Light Rust
 - Dense Rust
 - Gunite Lining
9. External Shell Color/Shade:
 - White/White
 - Aluminum/Specular
 - Aluminum/Diffuse
 - Gray/Light
 - Gray/Medium
 - Red/Primer
10. External Shell Condition: Good Poor
11. Roof Color/Shade:
 - White/White
 - Aluminum/Specular
 - Aluminum/Diffuse
 - Gray/Light
 - Gray/Medium
 - Red/Primer
12. Roof Condition: Good Poor

B. Rim Seal System:

1. Primary Seal: Mechanical Shoe Liquid-mounted Vapor-mounted
2. Secondary Seal: Shoe-mounted Rim-mounted None

C. Deck Characteristics:

1. Deck Type: Bolted Welded
2. Deck Fitting Category: Typical Detail

6. External Floating Roof Tank

A. Tank Characteristics

1. Diameter: _____ feet
2. Tank Volume: _____ gal
3. Turnovers per year: _____
4. Maximum Throughput: _____ gal/yr
5. Internal Shell Condition:
 - Light Rust
 - Dense Rust
 - Gunite Lining

MDEQ NOTICE OF INTENT FOR COVERAGE UNDER THE OIL PRODUCTION GENERAL PERMIT TO CONSTRUCT/OPERATE AIR EMISSIONS EQUIPMENT AT A SYNTHETIC MINOR SOURCE

Tank Summary **Section OPGP-E**

6. External Floating Roof Tank (continued)

A. Tank Characteristics (continued):

6. Paint Color/Shade:

- White/White Aluminum/Specular Aluminum/Diffuse
 Gray/Light Gray/Medium Red/Primer

7. Paint Condition: Good Poor

B. Roof Characteristics

1. Roof Type: Pontoon Double Deck

2. Roof Fitting Category: Typical Detail

C. Tank Construction and Rim-Seal System:

1. Tank Construction: Welded Riveted

2. Primary Seal:

- Mechanical Shoe Liquid-mounted Vapor-mounted

3. Secondary Seal

- None Shoe-mounted Rim-mounted Weather shield

7. Pollutant Emissions

A. Fixed Roof Emissions:

Pollutant ¹	Working Loss (tons/yr)	Breathing Loss (tons/yr)	Total Emissions (tons/yr)
VOC / HAP	No emissions occur from the tanks since gasses are routed to the flare.		

B. Floating Roof Emissions:

Pollutant ¹	Rim Seal Loss (tons/yr)	Withdrawal Loss (tons/yr)	Deck Fitting Loss (tons/yr)	Deck Seam Loss (tons/yr)	Landing Loss ² (tons/yr)	Total Emissions (tons/yr)

1. All regulated air pollutants including hazardous air pollutants emitted from this source should be listed in accordance with the OGP Application Instructions. A list of regulated air pollutants and a link to EPA's list of hazardous air pollutants is provided in the OGP Application Instructions.

2. Landing losses should be determined according to the procedures in *Organic Liquid Storage Tanks* chapter of EPA's AP-42 emission factors. If the roof is not landed at least once/yr, enter "NA".

MDEQ NOTICE OF INTENT FOR COVERAGE UNDER THE OIL PRODUCTION GENERAL PERMIT TO CONSTRUCT/OPERATE AIR EMISSIONS EQUIPMENT AT A SYNTHETIC MINOR SOURCE

Tank Summary

Section OPGP-E

1. Emission Point Description

- A. Emission Point Designation (Ref. No.): AA-008 (Oil Storage Tank No. 3)
- B. Product(s) Stored: Oil
- C. Status: Operating Proposed Under Construction
- D. Date of construction, reconstruction, or most recent modification (for existing sources) or date of anticipated construction: 2021

2. Tank Data

- A. Tank Specifications:
- | | | | |
|---|---------------|----------|-------------------|
| 1. Design capacity | <u>16,800</u> | gallons | |
| 2. True vapor pressure at storage temperature: | <u>11.55</u> | psia @ | <u>ambient</u> °F |
| 3. Maximum true vapor pressure (as defined in §60.111b) | <u>11.55</u> | psia @ | <u>ambient</u> °F |
| 4. Reid vapor pressure at storage temperature: | <u>11.55</u> | psia @ | <u>ambient</u> °F |
| 5. Density of product at storage temperature: | <u>7.2</u> | lb/gal | |
| 6. Molecular weight of product vapor at storage temp. | <u>48</u> | lb/lbmol | |
- B. Tank Orientation: Vertical Horizontal
- C. Type of Tank:
- Fixed Roof External Floating Roof Internal Floating Roof
- Pressure Variable Vapor Space Other: _____
- D. Is the tank equipped with a Vapor Recovery System and/or flare? Yes No
- If yes, describe below and include the efficiency of each.*
The tanks will be vented to the flare. If a VRU is necessary, it will be installed.
- E. Closest City:
- Jackson, MS Meridian, MS Tupelo, MS Mobile, AL
- New Orleans, LA Memphis, TN Baton Rouge, LA
- F. Is an E&P or similar report described in Condition 5.4(5) of the General Permit included for this tank in the Notice of Intent? Yes No

MDEQ NOTICE OF INTENT FOR COVERAGE UNDER THE OIL PRODUCTION GENERAL PERMIT TO CONSTRUCT/OPERATE AIR EMISSIONS EQUIPMENT AT A SYNTHETIC MINOR SOURCE

Tank Summary

Section OPGP-E

3. Horizontal Fixed Roof Tank

- A. Shell Length: _____ feet
 B. Shell Diameter: _____ feet
 C. Working Volume: _____ gal
 D. Maximum Throughput: _____ gal/yr
 E. Is the tank heated? Yes No
 F. Is the tank underground? Yes No
 G. Shell Color/Shade:
 Aluminum/Specular Aluminum/Diffuse
 Gray/Light Gray/Medium Red/Primer
 H. Shell Condition: Good Poor

4. Vertical Fixed Roof Tank

- A. Dimensions:
 1. Shell Height: _____ 20 _____ feet
 2. Shell Diameter: _____ 12 _____ feet
 3. Maximum Liquid Height: _____ 19 _____ feet
 4. Average Liquid Height: _____ ~10 _____ feet
 5. Working Volume: _____ 16,800 _____ gal
 6. Turnovers per year: _____ 91.25 _____ (est. for each oil storage tank)
 7. Maximum throughput: _____ 3.066 _____ MMgal/yr (for entire tank battery)
 8. Is the tank heated? Yes No
- B. Shell Characteristics:
 1. Shell Color/Shade:
 White/White Aluminum/Specular Aluminum/Diffuse
 Gray/Light Gray/Medium Red/Primer
 2. Shell Condition: Good Poor
- C. Roof Characteristics:
 1. Roof Color/Shade:
 White/White Aluminum/Specular Aluminum/Diffuse
 Gray/Light Gray/Medium Red/Primer
 2. Roof Condition: Good Poor
 3. Type: Cone Dome
 4. Height: _____ 1 _____ feet

MDEQ NOTICE OF INTENT FOR COVERAGE UNDER THE OIL PRODUCTION GENERAL PERMIT TO CONSTRUCT/OPERATE AIR EMISSIONS EQUIPMENT AT A SYNTHETIC MINOR SOURCE

Tank Summary

Section OPGP-E

5. Internal Floating Roof Tank

A. Tank Characteristics:

1. Diameter: _____ feet
2. Tank Volume: _____ gal
3. Turnovers per year: _____
4. Maximum Throughput: _____ gal/yr
5. Number of Columns: _____
6. Self-Supporting Roof? Yes No
7. Effective Column Diameter:

<input type="checkbox"/> 9"x7" Built-up Column	<input type="checkbox"/> 8" Diameter Pipe	<input type="checkbox"/> Unknown
--	---	----------------------------------
8. Internal Shell Condition:

<input type="checkbox"/> Light Rust	<input type="checkbox"/> Dense Rust	<input type="checkbox"/> Gunite Lining
-------------------------------------	-------------------------------------	--
9. External Shell Color/Shade:

<input type="checkbox"/> White/White	<input type="checkbox"/> Aluminum/Specular	<input type="checkbox"/> Aluminum/Diffuse
<input type="checkbox"/> Gray/Light	<input type="checkbox"/> Gray/Medium	<input type="checkbox"/> Red/Primer
10. External Shell Condition: Good Poor
11. Roof Color/Shade:

<input type="checkbox"/> White/White	<input type="checkbox"/> Aluminum/Specular	<input type="checkbox"/> Aluminum/Diffuse
<input type="checkbox"/> Gray/Light	<input type="checkbox"/> Gray/Medium	<input type="checkbox"/> Red/Primer
12. Roof Condition: Good Poor

B. Rim Seal System:

1. Primary Seal: Mechanical Shoe Liquid-mounted Vapor-mounted
2. Secondary Seal: Shoe-mounted Rim-mounted None

C. Deck Characteristics:

1. Deck Type: Bolted Welded
2. Deck Fitting Category: Typical Detail

6. External Floating Roof Tank

A. Tank Characteristics

1. Diameter: _____ feet
2. Tank Volume: _____ gal
3. Turnovers per year: _____
4. Maximum Throughput: _____ gal/yr
5. Internal Shell Condition:

<input type="checkbox"/> Light Rust	<input type="checkbox"/> Dense Rust	<input type="checkbox"/> Gunite Lining
-------------------------------------	-------------------------------------	--

MDEQ NOTICE OF INTENT FOR COVERAGE UNDER THE OIL PRODUCTION GENERAL PERMIT TO CONSTRUCT/OPERATE AIR EMISSIONS EQUIPMENT AT A SYNTHETIC MINOR SOURCE

Tank Summary

Section OPGP-E

6. External Floating Roof Tank (continued)

A. Tank Characteristics (continued):

6. Paint Color/Shade:

- White/White Aluminum/Specular Aluminum/Diffuse
 Gray/Light Gray/Medium Red/Primer

7. Paint Condition: Good Poor

B. Roof Characteristics

1. Roof Type: Pontoon Double Deck

2. Roof Fitting Category: Typical Detail

C. Tank Construction and Rim-Seal System:

1. Tank Construction: Welded Riveted

2. Primary Seal:

- Mechanical Shoe Liquid-mounted Vapor-mounted

3. Secondary Seal

- None Shoe-mounted Rim-mounted Weather shield

7. Pollutant Emissions

A. Fixed Roof Emissions:

Pollutant ¹	Working Loss (tons/yr)	Breathing Loss (tons/yr)	Total Emissions (tons/yr)
VOC / HAP	No emissions occur from the tanks since gasses are routed to the flare.		

B. Floating Roof Emissions:

Pollutant ¹	Rim Seal Loss (tons/yr)	Withdrawal Loss (tons/yr)	Deck Fitting Loss (tons/yr)	Deck Seam Loss (tons/yr)	Landing Loss ² (tons/yr)	Total Emissions (tons/yr)

1. All regulated air pollutants including hazardous air pollutants emitted from this source should be listed in accordance with the OGP Application Instructions. A list of regulated air pollutants and a link to EPA's list of hazardous air pollutants is provided in the OGP Application Instructions.

2. Landing losses should be determined according to the procedures in *Organic Liquid Storage Tanks* chapter of EPA's AP-42 emission factors. If the roof is not landed at least once/yr, enter "NA".

MDEQ NOTICE OF INTENT FOR COVERAGE UNDER THE OIL PRODUCTION GENERAL PERMIT TO CONSTRUCT/OPERATE AIR EMISSIONS EQUIPMENT AT A SYNTHETIC MINOR SOURCE

Tank Summary

Section OPGP-E

1. Emission Point Description

- A. Emission Point Designation (Ref. No.): AA-008 (Oil Storage Tank No. 4)
- B. Product(s) Stored: Oil
- C. Status: Operating Proposed Under Construction
- D. Date of construction, reconstruction, or most recent modification (for existing sources) or date of anticipated construction: 2021

2. Tank Data

- A. Tank Specifications:
- | | | | |
|---|---------------|----------|-------------------|
| 1. Design capacity | <u>16,800</u> | gallons | |
| 2. True vapor pressure at storage temperature: | <u>11.55</u> | psia @ | <u>ambient</u> °F |
| 3. Maximum true vapor pressure (as defined in §60.111b) | <u>11.55</u> | psia @ | <u>ambient</u> °F |
| 4. Reid vapor pressure at storage temperature: | <u>11.55</u> | psia @ | <u>ambient</u> °F |
| 5. Density of product at storage temperature: | <u>7.2</u> | lb/gal | |
| 6. Molecular weight of product vapor at storage temp. | <u>48</u> | lb/lbmol | |
- B. Tank Orientation: Vertical Horizontal
- C. Type of Tank:
- Fixed Roof External Floating Roof Internal Floating Roof
- Pressure Variable Vapor Space Other: _____
- D. Is the tank equipped with a Vapor Recovery System and/or flare? Yes No
- If yes, describe below and include the efficiency of each.*
The tanks will be vented to the flare. If a VRU is necessary, it will be installed.
- E. Closest City:
- Jackson, MS Meridian, MS Tupelo, MS Mobile, AL
- New Orleans, LA Memphis, TN Baton Rouge, LA
- F. Is an E&P or similar report described in Condition 5.4(5) of the General Permit included for this tank in the Notice of Intent? Yes No

MDEQ NOTICE OF INTENT FOR COVERAGE UNDER THE OIL PRODUCTION GENERAL PERMIT TO CONSTRUCT/OPERATE AIR EMISSIONS EQUIPMENT AT A SYNTHETIC MINOR SOURCE

Tank Summary

Section OPGP-E

3. Horizontal Fixed Roof Tank

- A. Shell Length: _____ feet
 B. Shell Diameter: _____ feet
 C. Working Volume: _____ gal
 D. Maximum Throughput: _____ gal/yr
 E. Is the tank heated? Yes No
 F. Is the tank underground? Yes No
 G. Shell Color/Shade:
 Aluminum/Specular Aluminum/Diffuse
 Gray/Light Gray/Medium Red/Primer
 H. Shell Condition: Good Poor

4. Vertical Fixed Roof Tank

- A. Dimensions:
 1. Shell Height: _____ 20 _____ feet
 2. Shell Diameter: _____ 12 _____ feet
 3. Maximum Liquid Height: _____ 19 _____ feet
 4. Average Liquid Height: _____ ~10 _____ feet
 5. Working Volume: _____ 16,800 _____ gal
 6. Turnovers per year: _____ 91.25 _____ (est. for each oil storage tank)
 7. Maximum throughput: _____ 3.066 _____ MMgal/yr (for entire tank battery)
 8. Is the tank heated? Yes No
- B. Shell Characteristics:
 1. Shell Color/Shade:
 White/White Aluminum/Specular Aluminum/Diffuse
 Gray/Light Gray/Medium Red/Primer
 2. Shell Condition: Good Poor
- C. Roof Characteristics:
 1. Roof Color/Shade:
 White/White Aluminum/Specular Aluminum/Diffuse
 Gray/Light Gray/Medium Red/Primer
 2. Roof Condition: Good Poor
 3. Type: Cone Dome
 4. Height: _____ 1 _____ feet

MDEQ NOTICE OF INTENT FOR COVERAGE UNDER THE OIL PRODUCTION GENERAL PERMIT TO CONSTRUCT/OPERATE AIR EMISSIONS EQUIPMENT AT A SYNTHETIC MINOR SOURCE

Tank Summary

Section OPGP-E

5. Internal Floating Roof Tank

A. Tank Characteristics:

1. Diameter: _____ feet
2. Tank Volume: _____ gal
3. Turnovers per year: _____
4. Maximum Throughput: _____ gal/yr
5. Number of Columns: _____
6. Self-Supporting Roof? Yes No
7. Effective Column Diameter:
 - 9"x7" Built-up Column
 - 8" Diameter Pipe
 - Unknown
8. Internal Shell Condition:
 - Light Rust
 - Dense Rust
 - Gunite Lining
9. External Shell Color/Shade:
 - White/White
 - Aluminum/Specular
 - Aluminum/Diffuse
 - Gray/Light
 - Gray/Medium
 - Red/Primer
10. External Shell Condition: Good Poor
11. Roof Color/Shade:
 - White/White
 - Aluminum/Specular
 - Aluminum/Diffuse
 - Gray/Light
 - Gray/Medium
 - Red/Primer
12. Roof Condition: Good Poor

B. Rim Seal System:

1. Primary Seal: Mechanical Shoe Liquid-mounted Vapor-mounted
2. Secondary Seal: Shoe-mounted Rim-mounted None

C. Deck Characteristics:

1. Deck Type: Bolted Welded
2. Deck Fitting Category: Typical Detail

6. External Floating Roof Tank

A. Tank Characteristics

1. Diameter: _____ feet
2. Tank Volume: _____ gal
3. Turnovers per year: _____
4. Maximum Throughput: _____ gal/yr
5. Internal Shell Condition:
 - Light Rust
 - Dense Rust
 - Gunite Lining

MDEQ NOTICE OF INTENT FOR COVERAGE UNDER THE OIL PRODUCTION GENERAL PERMIT TO CONSTRUCT/OPERATE AIR EMISSIONS EQUIPMENT AT A SYNTHETIC MINOR SOURCE

Tank Summary

Section OPGP-E

6. External Floating Roof Tank (continued)

A. Tank Characteristics (continued):

6. Paint Color/Shade:

- White/White Aluminum/Specular Aluminum/Diffuse
 Gray/Light Gray/Medium Red/Primer

7. Paint Condition:

- Good Poor

B. Roof Characteristics

1. Roof Type: Pontoon Double Deck

2. Roof Fitting Category: Typical Detail

C. Tank Construction and Rim-Seal System:

1. Tank Construction: Welded Riveted

2. Primary Seal:

- Mechanical Shoe Liquid-mounted Vapor-mounted

3. Secondary Seal

- None Shoe-mounted Rim-mounted Weather shield

7. Pollutant Emissions

A. Fixed Roof Emissions:

Pollutant ¹	Working Loss (tons/yr)	Breathing Loss (tons/yr)	Total Emissions (tons/yr)
VOC / HAP	No emissions occur from the tanks since gasses are routed to the flare.		

B. Floating Roof Emissions:

Pollutant ¹	Rim Seal Loss (tons/yr)	Withdrawal Loss (tons/yr)	Deck Fitting Loss (tons/yr)	Deck Seam Loss (tons/yr)	Landing Loss ² (tons/yr)	Total Emissions (tons/yr)

1. All regulated air pollutants including hazardous air pollutants emitted from this source should be listed in accordance with the OGP Application Instructions. A list of regulated air pollutants and a link to EPA's list of hazardous air pollutants is provided in the OGP Application Instructions.

2. Landing losses should be determined according to the procedures in *Organic Liquid Storage Tanks* chapter of EPA's AP-42 emission factors. If the roof is not landed at least once/yr, enter "NA".

MDEQ NOTICE OF INTENT FOR COVERAGE UNDER THE OIL PRODUCTION GENERAL PERMIT TO CONSTRUCT/OPERATE AIR EMISSIONS EQUIPMENT AT A SYNTHETIC MINOR SOURCE

Tank Summary

Section OPGP-E

1. Emission Point Description

- A. Emission Point Designation (Ref. No.): AA-008 (Water Storage Tank No. 1)
- B. Product(s) Stored: Produced Water
- C. Status: Operating Proposed Under Construction
- D. Date of construction, reconstruction, or most recent modification (for existing sources) or date of anticipated construction: 2021

2. Tank Data

- A. Tank Specifications:
- | | | | |
|---|---------------|----------|-------------------|
| 1. Design capacity | <u>16,800</u> | gallons | |
| 2. True vapor pressure at storage temperature: | <u>1.15</u> | psia @ | <u>ambient</u> °F |
| 3. Maximum true vapor pressure (as defined in §60.111b) | <u>1.15</u> | psia @ | <u>ambient</u> °F |
| 4. Reid vapor pressure at storage temperature: | <u>1.15</u> | psia @ | <u>ambient</u> °F |
| 5. Density of product at storage temperature: | <u>7.2</u> | lb/gal | |
| 6. Molecular weight of product vapor at storage temp. | <u>48</u> | lb/lbmol | |
- B. Tank Orientation: Vertical Horizontal
- C. Type of Tank:
- Fixed Roof External Floating Roof Internal Floating Roof
- Pressure Variable Vapor Space Other: _____
- D. Is the tank equipped with a Vapor Recovery System and/or flare? Yes No
- If yes, describe below and include the efficiency of each.*
The tanks will be vented to the flare. If a VRU is necessary, it will be installed.
- E. Closest City:
- Jackson, MS Meridian, MS Tupelo, MS Mobile, AL
- New Orleans, LA Memphis, TN Baton Rouge, LA
- F. Is an E&P or similar report described in Condition 5.4(5) of the General Permit included for this tank in the Notice of Intent? Yes No

MDEQ NOTICE OF INTENT FOR COVERAGE UNDER THE OIL PRODUCTION GENERAL PERMIT TO CONSTRUCT/OPERATE AIR EMISSIONS EQUIPMENT AT A SYNTHETIC MINOR SOURCE

Tank Summary

Section OPGP-E

3. Horizontal Fixed Roof Tank

- A. Shell Length: _____ feet
 B. Shell Diameter: _____ feet
 C. Working Volume: _____ gal
 D. Maximum Throughput: _____ gal/yr
 E. Is the tank heated? Yes No
 F. Is the tank underground? Yes No
 G. Shell Color/Shade:
 Aluminum/Specular Aluminum/Diffuse
 Gray/Light Gray/Medium Red/Primer
 H. Shell Condition: Good Poor

4. Vertical Fixed Roof Tank

- A. Dimensions:
 1. Shell Height: _____ 20 _____ feet
 2. Shell Diameter: _____ 12 _____ feet
 3. Maximum Liquid Height: _____ 19 _____ feet
 4. Average Liquid Height: _____ ~10 _____ feet
 5. Working Volume: _____ 16,800 _____ gal
 6. Turnovers per year: _____ 1 _____
 7. Maximum throughput: _____ 15,330 _____ gal/yr
 8. Is the tank heated? Yes No
- B. Shell Characteristics:
 1. Shell Color/Shade:
 White/White Aluminum/Specular Aluminum/Diffuse
 Gray/Light Gray/Medium Red/Primer
 2. Shell Condition: Good Poor
- C. Roof Characteristics:
 1. Roof Color/Shade:
 White/White Aluminum/Specular Aluminum/Diffuse
 Gray/Light Gray/Medium Red/Primer
 2. Roof Condition: Good Poor
 3. Type: Cone Dome
 4. Height: _____ 1 _____ feet

MDEQ NOTICE OF INTENT FOR COVERAGE UNDER THE OIL PRODUCTION GENERAL PERMIT TO CONSTRUCT/OPERATE AIR EMISSIONS EQUIPMENT AT A SYNTHETIC MINOR SOURCE

Tank Summary

Section OPGP-E

5. Internal Floating Roof Tank

A. Tank Characteristics:

1. Diameter: _____ feet
2. Tank Volume: _____ gal
3. Turnovers per year: _____
4. Maximum Throughput: _____ gal/yr
5. Number of Columns: _____
6. Self-Supporting Roof? Yes No
7. Effective Column Diameter:

<input type="checkbox"/> 9"x7" Built-up Column	<input type="checkbox"/> 8" Diameter Pipe	<input type="checkbox"/> Unknown
--	---	----------------------------------
8. Internal Shell Condition:

<input type="checkbox"/> Light Rust	<input type="checkbox"/> Dense Rust	<input type="checkbox"/> Gunite Lining
-------------------------------------	-------------------------------------	--
9. External Shell Color/Shade:

<input type="checkbox"/> White/White	<input type="checkbox"/> Aluminum/Specular	<input type="checkbox"/> Aluminum/Diffuse
<input type="checkbox"/> Gray/Light	<input type="checkbox"/> Gray/Medium	<input type="checkbox"/> Red/Primer
10. External Shell Condition: Good Poor
11. Roof Color/Shade:

<input type="checkbox"/> White/White	<input type="checkbox"/> Aluminum/Specular	<input type="checkbox"/> Aluminum/Diffuse
<input type="checkbox"/> Gray/Light	<input type="checkbox"/> Gray/Medium	<input type="checkbox"/> Red/Primer
12. Roof Condition: Good Poor

B. Rim Seal System:

1. Primary Seal: Mechanical Shoe Liquid-mounted Vapor-mounted
2. Secondary Seal: Shoe-mounted Rim-mounted None

C. Deck Characteristics:

1. Deck Type: Bolted Welded
2. Deck Fitting Category: Typical Detail

6. External Floating Roof Tank

A. Tank Characteristics

1. Diameter: _____ feet
2. Tank Volume: _____ gal
3. Turnovers per year: _____
4. Maximum Throughput: _____ gal/yr
5. Internal Shell Condition:

<input type="checkbox"/> Light Rust	<input type="checkbox"/> Dense Rust	<input type="checkbox"/> Gunite Lining
-------------------------------------	-------------------------------------	--

MDEQ NOTICE OF INTENT FOR COVERAGE UNDER THE OIL PRODUCTION GENERAL PERMIT TO CONSTRUCT/OPERATE AIR EMISSIONS EQUIPMENT AT A SYNTHETIC MINOR SOURCE

Tank Summary **Section OPGP-E**

6. External Floating Roof Tank (continued)

A. Tank Characteristics (continued):

6. Paint Color/Shade:

- White/White Aluminum/Specular Aluminum/Diffuse
 Gray/Light Gray/Medium Red/Primer

7. Paint Condition: Good Poor

B. Roof Characteristics

1. Roof Type: Pontoon Double Deck

2. Roof Fitting Category: Typical Detail

C. Tank Construction and Rim-Seal System:

1. Tank Construction: Welded Riveted

2. Primary Seal:
 Mechanical Shoe Liquid-mounted Vapor-mounted

3. Secondary Seal
 None Shoe-mounted Rim-mounted Weather shield

7. Pollutant Emissions

A. Fixed Roof Emissions:

Pollutant ¹	Working Loss (tons/yr)	Breathing Loss (tons/yr)	Total Emissions (tons/yr)
VOC / HAP	No emissions occur from the tank since gasses are routed to the flare.		

B. Floating Roof Emissions:

Pollutant ¹	Rim Seal Loss (tons/yr)	Withdrawal Loss (tons/yr)	Deck Fitting Loss (tons/yr)	Deck Seam Loss (tons/yr)	Landing Loss ² (tons/yr)	Total Emissions (tons/yr)

1. All regulated air pollutants including hazardous air pollutants emitted from this source should be listed in accordance with the OGP Application Instructions. A list of regulated air pollutants and a link to EPA's list of hazardous air pollutants is provided in the OGP Application Instructions.

2. Landing losses should be determined according to the procedures in *Organic Liquid Storage Tanks* chapter of EPA's AP-42 emission factors. If the roof is not landed at least once/yr, enter "NA".

MDEQ NOTICE OF INTENT FOR COVERAGE UNDER THE OIL PRODUCTION GENERAL PERMIT TO CONSTRUCT/OPERATE AIR EMISSIONS EQUIPMENT AT A SYNTHETIC MINOR SOURCE

Flare

Section OPGP-F

1. Equipment Description

- A. Emission Point Designation (Ref. No.): AA-001
- B. Equipment Description (include the process(es) that the flare controls emissions from): The flare is utilized to combust produced gas, and to combust emissions from the heater treater and oil and water storage tanks.
- C. Manufacturer: Custom D. Model: Custom
- E. Status: Operating Proposed Under Construction
- F. Requesting a federally enforceable condition to route tank emissions to the flare.

2. System Data

- A. Efficiency: 98 % Controlling the following pollutant(s): VOC
Efficiency: 98 % Controlling the following pollutant(s): HAP
Reason for different efficiency: _____
- B. Flare Data (if applicable):
1. Flare type: Non-assisted Steam-assisted Air-assisted
 Other: _____
2. Net heating value of combusted gas: Est. 1,000 Btu/scf
3. Design exit velocity: N/A ft/sec
4. System: Auto-ignitor Continuous Flame
5. Is the presence of a flare pilot flame monitored? Yes No
If yes, please describe the monitoring: thermocouple
6. Is the auto-ignitor system monitored? Yes No
If yes, please describe the monitoring: Daily inspections

**MDEQ NOTICE OF INTENT FOR COVERAGE UNDER THE OIL PRODUCTION GENERAL PERMIT TO
CONSTRUCT/OPERATE AIR EMISSIONS EQUIPMENT AT A SYNTHETIC MINOR SOURCE**

Compliance Plan

Section OPGP-G

Part 1. Equipment List

List all equipment and the corresponding federal and/or state regulation that is applicable. Clearly identify federal regulations from state requirements. Provide the expected or actual construction date, startup date and removal date if the equipment is no longer on site.

EMISSION UNIT (RefNo.)	FEDERAL or STATE REGULATION Ex. 40 CFR Part _____, Subpart _____ Ex. 11 Miss. Admin. Code Pt. 2, R. 1.4.B(2).	CONSTRUCTION DATE	STARTUP DATE	REMOVAL DATE
Example: Engines	40 CFR 63, Subpart ZZZZ	10/01/2002	11/15/2019	N/A
Example: Fugitive Emissions	40 CFR 60, Subpart OOOOa	10/01/2019	11/15/2019	N/A
Example: Flare	11 Miss. Admin. Code Pt. 2, R.1.4.B(2).	12/01/2019	12/02/2019	N/A
<i>This list of examples is not intended to be conclusive for each type of emission source. This list only provides examples of how the table should be completed.</i>				
AA-001 Flare and facility wide	11 Miss. Admin. Code Pt. 2, R.1.4.B(2).	04/2019	04/2019	N/A
AA-002, AA-002a, Engines	40 CFR 63, Subpart ZZZZ	04/2019	04/2019	N/A
AA-002, AA-002a, AA-006a, AA-010	11 Miss. Admin. Code Pt. 2, R.1.3.B.	04/2019	04/2019	N/A
AA-002, AA-002a, AA-006a, AA-010	11 Miss. Admin. Code Pt. 2, R.1.3.D(1)(a).	04/2019	04/2019	N/A
AA-003 Fugitive Emissions	40 CFR 60, Subpart OOOOa	04/2019	04/2019	N/A

**MDEQ NOTICE OF INTENT FOR COVERAGE UNDER THE OIL PRODUCTION GENERAL PERMIT TO
CONSTRUCT/OPERATE AIR EMISSIONS EQUIPMENT AT A SYNTHETIC MINOR SOURCE**

Compliance Plan

Section OPGP-G

Part 1. Equipment List

List all equipment and the corresponding federal and/or state regulation that is applicable. Clearly identify federal regulations from state requirements. Provide the expected or actual construction date, startup date and removal date if the equipment is no longer on site.

EMISSION UNIT (Ref No.)	FEDERAL or STATE REGULATION Ex. 40 CFR Part _____, Subpart _____ Ex. 11 Miss. Admin. Code Pt. 2, R. 1.4.B(2).	CONSTRUCTION DATE	STARTUP DATE	REMOVAL DATE
AA-000 Well affected facility	40 CFR 60, Subpart OOOOa	01/01/2023 (est.)	03/03/2023 (est.)	N/A

**MDEQ NOTICE OF INTENT FOR COVERAGE UNDER THE OIL PRODUCTION GENERAL PERMIT TO
CONSTRUCT/OPERATE AIR EMISSIONS EQUIPMENT AT A SYNTHETIC MINOR SOURCE**

Compliance Plan

Section OPGP-G

Part 2. Applicable Requirements

List all applicable state and federal requirements, including emission limits, operating restrictions, etc., and the applicable test methods or monitoring used to demonstrate compliance with each applicable requirement. Clearly identify federal regulations from state requirements. Provide the compliance status as of the day the application is signed.

EMISSION UNIT (Ref No.)	APPLICABLE REQUIREMENT (Specific Regulatory citation)	POLLUTANT	LIMITS/ REQUIREMENTS	TEST METHOD/ COMPLIANCE MONITORING
Example: Compressor	Item 8 of Table 2d of 40 CFR 63, Subpart ZZZZ	HAPs	Change oil and filter every 2,160 hours of operation or annually, whichever comes first; Inspect spark plugs every 2,160 hours of operation or annually, whichever comes first, and replace as necessary; and inspect all hoses and belts every 2,160 hours of operation or annually, whichever comes first, and replace as necessary.	Monitoring of compressor hours of operation
Example: Tanks	40 CFR 60.5395(a)(2)	VOC and Methane	Must reduce VOC emissions by 95.0 percent within 60 days after startup of production.	Tank emissions are routed to the flare for destruction at all times of operations.
Example: Flare	11 Miss. Admin. Code Pt. 2, R.1.4.B(2).	H ₂ S	1 grain H ₂ S per 100 standard cubic feet (1 gr/100 scf)	Recordkeeping of H ₂ S composition of gas by gas analysis; Maintenance of continuous flame for gas combustion.
<i>This list of examples is not intended to be conclusive for each type of emission source. This list only provides examples of how the table should be completed.</i>				
AA-001, Flare & facility wide	1 Miss. Admin. Code Pt. 2, R.1.4.B(2).	H ₂ S	Any gas stream containing as much as 1 grain H ₂ S per 100 standard cubic feet (1 gr/100 scf) must be incinerated prior to discharge to the atmosphere	Recordkeeping of H ₂ S composition of gas by gas analysis; Maintenance of continuous flame for gas combustion.
AA-002, AA-002a	40 CFR 63, subpart ZZZZ, (§63.6590(a))	HAP	Applicability	Applicability Only
AA-002, AA-002a	40 CFR 63, subpart ZZZZ, (§63.6603 & Table 2(d))	HAP	Change oil and filter every 1,440 hours of operation or annually, whichever comes first; b. Inspect spark plugs every	Monitoring engine hours of operation

**MDEQ NOTICE OF INTENT FOR COVERAGE UNDER THE OIL PRODUCTION GENERAL PERMIT TO
CONSTRUCT/OPERATE AIR EMISSIONS EQUIPMENT AT A SYNTHETIC MINOR SOURCE**

Compliance Plan

Section OPGP-G

Part 2. Applicable Requirements

List all applicable state and federal requirements, including emission limits, operating restrictions, etc., and the applicable test methods or monitoring used to demonstrate compliance with each applicable requirement. Clearly identify federal regulations from state requirements. Provide the compliance status as of the day the application is signed.

EMISSION UNIT (Ref No.)	APPLICABLE REQUIREMENT (Specific Regulatory citation)	POLLUTANT	LIMITS/ REQUIREMENTS	TEST METHOD/ COMPLIANCE MONITORING
AA-002, AA-002a	40 CFR 63, subpart ZZZZ, (§63.6605)	HAP	1,440 hours of operation or annually, whichever comes first, and replace as necessary c. Inspect all hoses and belts every 1,440 hours of operation or annually, whichever comes first, and replace as necessary.	
AA-002, AA-002a	40 CFR 63, subpart ZZZZ, (§63.6640 (a) and Table 6)	HAP	Continuous compliance and General Duty to operate and maintain in a manner consistent with safety and good air pollution control practices to minimize emissions i. Operating and maintaining the stationary RICE according to the manufacturer's emission-related operation and maintenance instructions; or ii. Develop and follow your own maintenance plan	Process Knowledge
AA-002, AA-002a	40 CFR 63, subpart ZZZZ, (§63.6655 (a),(d) and (e))	HAP	Recordkeeping Requirements	Recordkeeping
AA-002, AA-002a	40 CFR 63, subpart ZZZZ, (§63.6660 (a),(b) and (c))	HAP	General recordkeeping requirements	Recordkeeping
AA-002, AA-002a	40 CFR 63, subpart ZZZZ, (§63.6640 (b))	HAP	Report any failure to perform a required work practice as scheduled	Reporting
AA-002, AA-002a	40 CFR 63, subpart ZZZZ, (§63.6665 (a) and Table 8)	HAP	Applicable requirements under 40 CFR 63 subpart A	Applicability

**MDEQ NOTICE OF INTENT FOR COVERAGE UNDER THE OIL PRODUCTION GENERAL PERMIT TO
CONSTRUCT/OPERATE AIR EMISSIONS EQUIPMENT AT A SYNTHETIC MINOR SOURCE**

Compliance Plan

Section OPGP-G

Part 2. Applicable Requirements

List all applicable state and federal requirements, including emission limits, operating restrictions, etc., and the applicable test methods or monitoring used to demonstrate compliance with each applicable requirement. Clearly identify federal regulations from state requirements. Provide the compliance status as of the day the application is signed.

EMISSION UNIT (Ref No.)	APPLICABLE REQUIREMENT (Specific Regulatory citation)	POLLUTANT	LIMITS/ REQUIREMENTS	TEST METHOD/ COMPLIANCE MONITORING
AA-003 Fugitive Emissions	40 CFR 60.5365a(i)	VOC and Methane	Applicability	Applicability only
AA-003 Fugitive Emissions	40 CFR 60.5397a(a-g)	VOC and Methane	Develop a fugitive emission monitoring plan	Upon Startup
AA-003 Fugitive Emissions	40 CFR 60.5397a(h)	VOC and Methane	Fugitive emission source repair or replacement requirements	Written Plan development
AA-003 Fugitive Emissions	40 CFR 60.5425a and Table 3	VOC and Methane	Applicability of General Provisions of 40 CFR 60, Subpart A	Applicability only
AA-003 Fugitive Emissions	40 CFR 60.5410a(j)	VOC and Methane	Demonstration of initial compliance	Monitoring
AA-003 Fugitive Emissions	40 CFR 60.415a(h)	VOC and Methane	Demonstration of continuous compliance	Monitoring
AA-003 Fugitive Emissions	40 CFR 60.5420a(c)	VOC and Methane	Recordkeeping requirements	Monitoring and Recordkeeping
AA-003 Fugitive Emissions	40 CFR 60.5420a(b)	VOC and Methane	Reporting requirements	Reporting
AA-008 Storage Tanks	40 CFR 60.5365a(e)	VOC and Methane	Applicability determination may take into account legally and practically enforceable limit on tank emissions	Applicability Only. Federally enforceable limit requested for avoidance.

**MDEQ NOTICE OF INTENT FOR COVERAGE UNDER THE OIL PRODUCTION GENERAL PERMIT TO
CONSTRUCT/OPERATE AIR EMISSIONS EQUIPMENT AT A SYNTHETIC MINOR SOURCE**

Compliance Plan

Section OPGP-G

Part 2. Applicable Requirements

List all applicable state and federal requirements, including emission limits, operating restrictions, etc., and the applicable test methods or monitoring used to demonstrate compliance with each applicable requirement. Clearly identify federal regulations from state requirements. Provide the compliance status as of the day the application is signed.

EMISSION UNIT (Ref No.)	APPLICABLE REQUIREMENT (Specific Regulatory citation)	POLLUTANT	LIMITS/ REQUIREMENTS	TEST METHOD/ COMPLIANCE MONITORING
AA-000 Well affected facility	40 CFR 60.5365a(a)	VOC	Applicability	Process Knowledge
AA-000 Well affected facility	40 CFR 60.5375a(a)	VOC	Completion standards/procedures for VOC control	Process Knowledge
AA-000 Well affected facility	40 CFR 60.5410a(a) 40 CFR 60.5415a(a)	VOC	Submit notification, annual report, maintain log of records, as applicable	Recordkeeping and Reporting
AA-000 Well affected facility	40 CFR 60.5420a	VOC	Specific notification, recordkeeping and reporting requirements.	Recordkeeping and Reporting

FIGURES

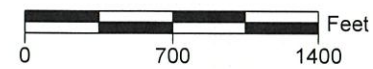
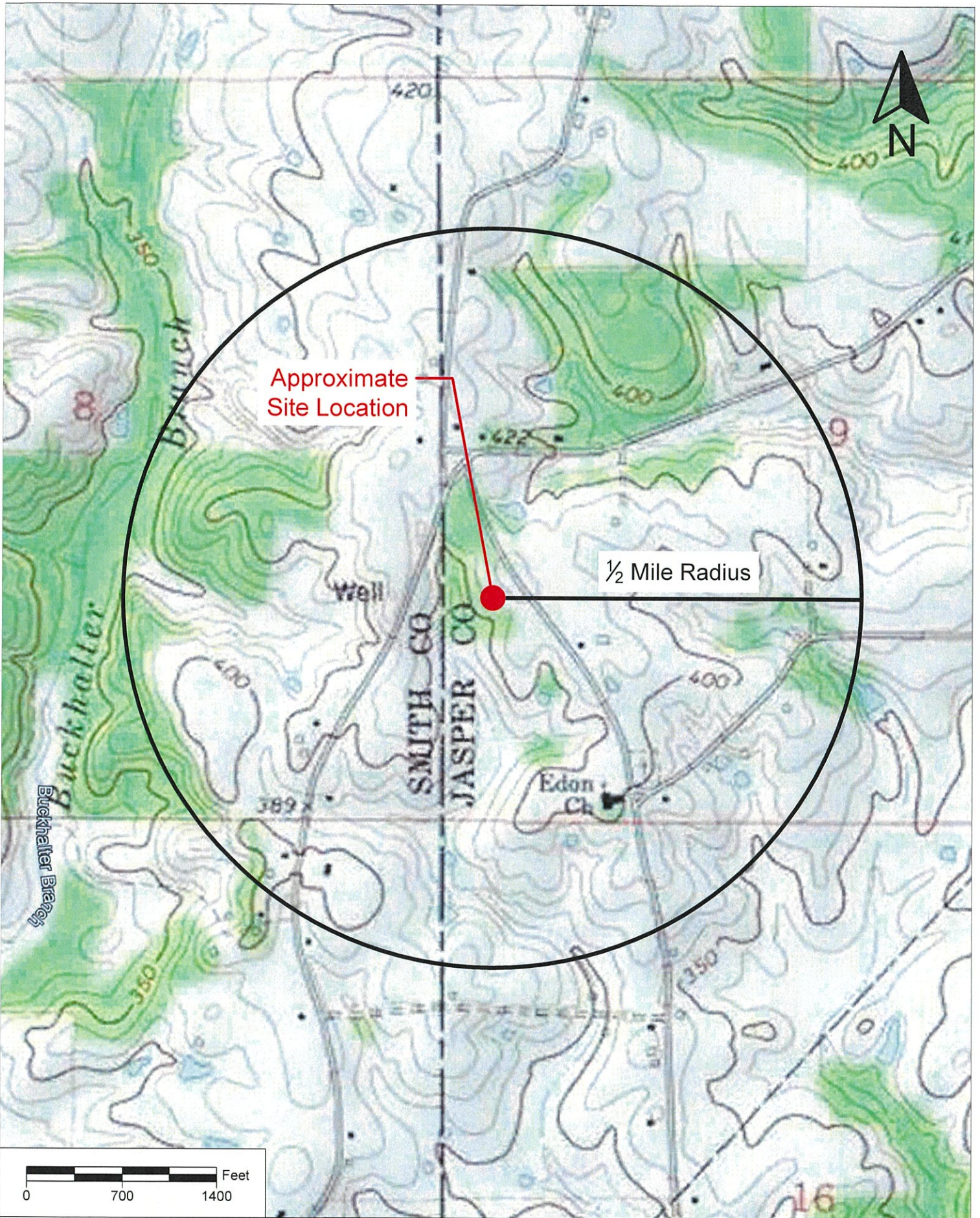

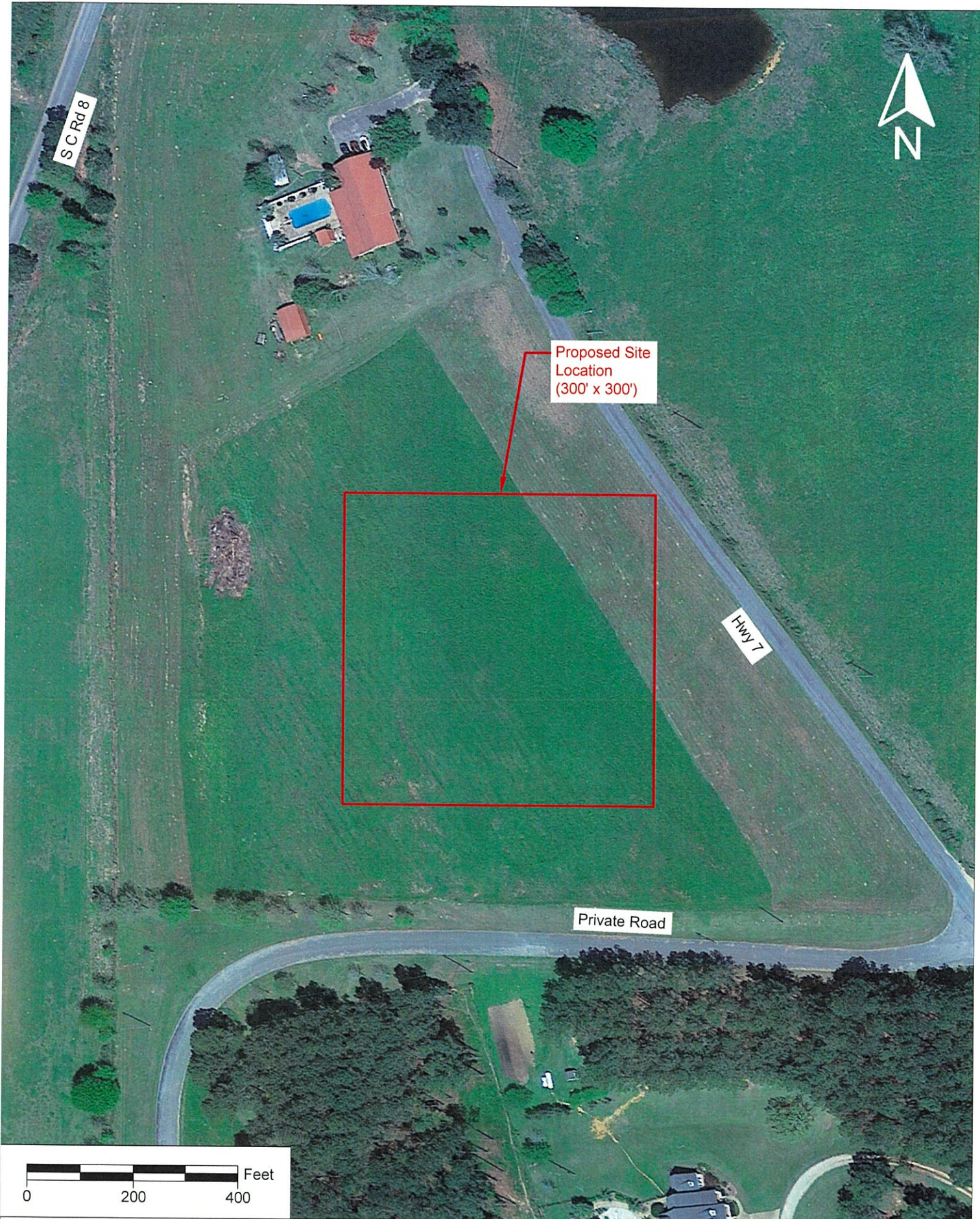

Proposed Site Location (300' x 300')



S C Rd 8

Hwy 7

Private Road



Venture Oil & Gas, Inc.
King 9-12 #1 Site
31.84714, -89.31565
Smith County, Mississippi

Figure Number: 2
Figure Name: Site Location Aerial Map
Project:
Drawn By: TF
Date Drawn: 7/27/2023



LEGEND
 Chain Link Fence
 Facility Boundary

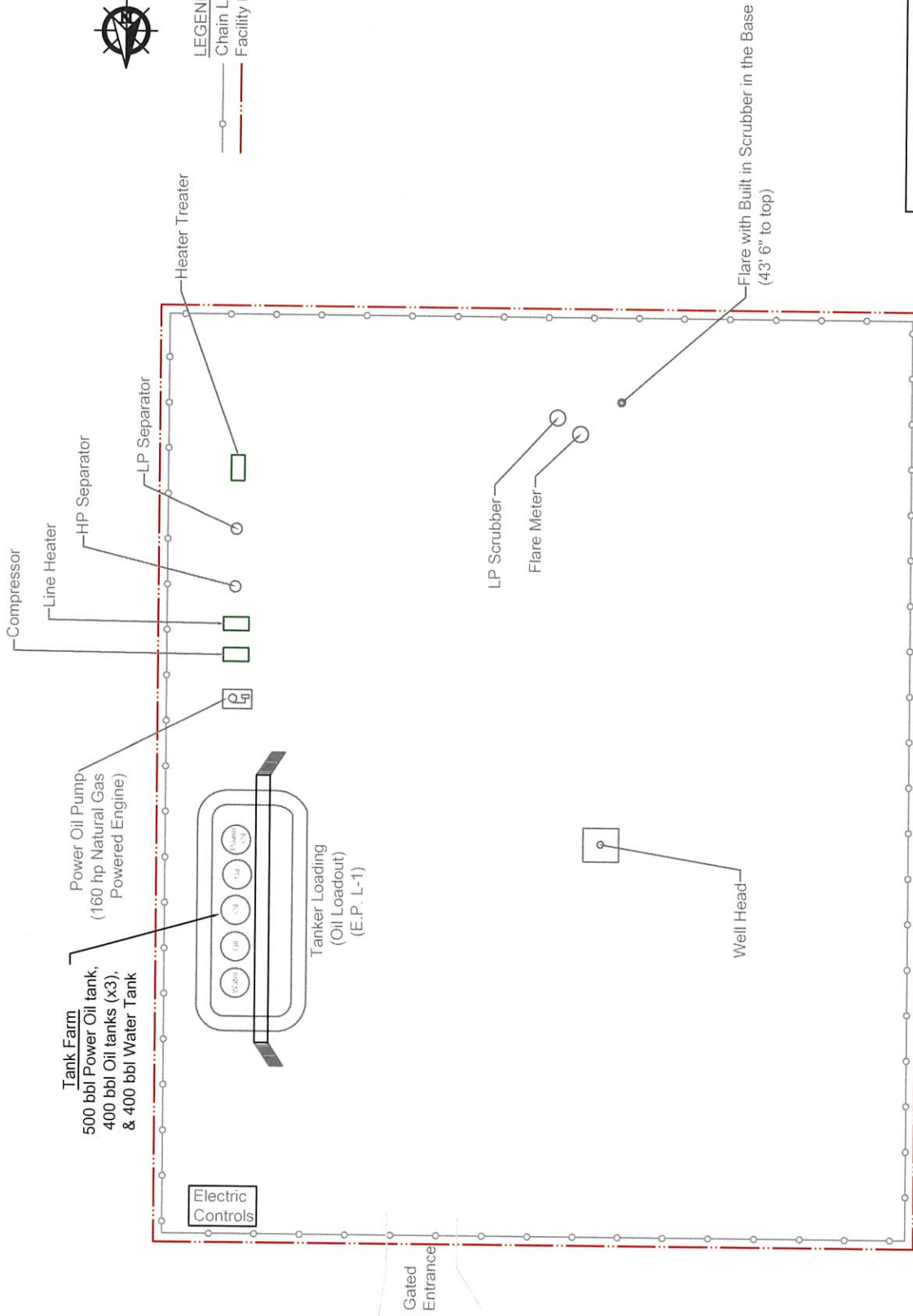

VENTURE OIL & GAS, INC.

EQUIPMENT LAYOUT

King 9-12 No. 1

Jasper County, Mississippi

FC&E ENGINEERING, LLC
 BRANDON, MISSISSIPPI
 (601) 824-1860



Drawn By: CC - Reviewed By: TC - Date Drawn: 7/26/2023

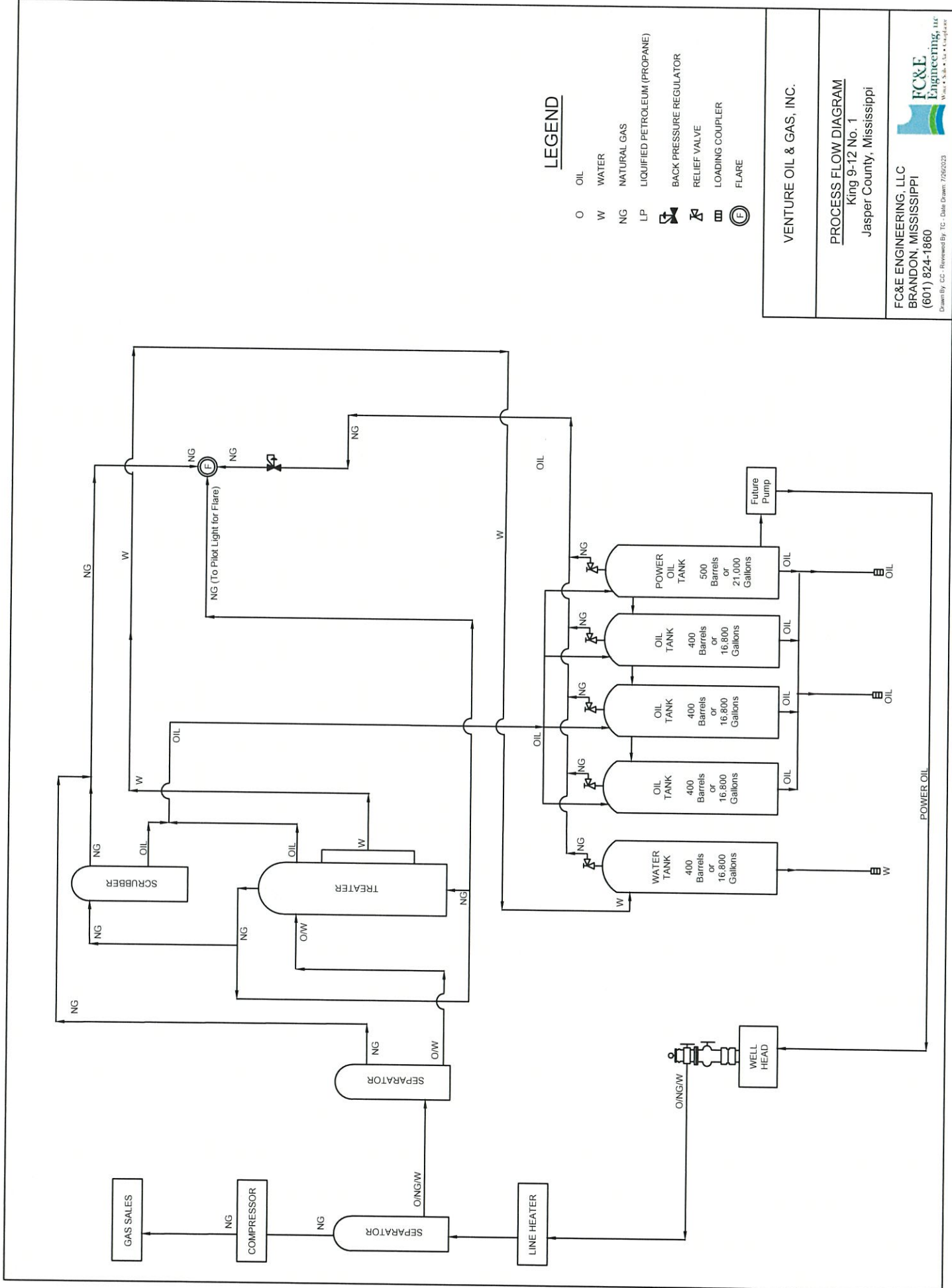

LEGEND

- O OIL
- W WATER
- NG NATURAL GAS
- LP LIQUIFIED PETROLEUM (PROPANE)
- BACK PRESSURE REGULATOR
- RELIEF VALVE
- LOADING COUPLER
- FLARE

VENTURE OIL & GAS, INC.

PROCESS FLOW DIAGRAM
 King 9-12 No. 1
 Jasper County, Mississippi

FC&E ENGINEERING, LLC
 BRANDON, MISSISSIPPI
 (601) 824-1860

FC&E
 Engineering, LLC
 W.A.C. • S.B. • L.L. • H. • J. • R. • L.

Drawn By: CC - Reviewed By: TC - Date Drawn: 7/26/2023

Venture King 9-12 No. 1 Tank Battery
Oil General Permit Coverage Application

ATTACHMENT A

Calculations for King 9-12 No. 1 Tank Battery

Site Information for Calculations

Site Name: King 9-12 No. 1 Tank Battery	
Potential Crude Production	127,750 bbl/yr
Potential Gas production	273,750 mcf/yr
Potential Produced Water	3,650 bbl/yr
Initial Crude Production	350 bbl/day (expected maximum daily production)
Initial Gas Production	750 mcf/day (expected maximum daily production)
Initial Water Production	10 bbl/day (expected maximum daily production)
Crude Gravity	49
Oil tank W&B Losses	1.31 SCF/stock tank bbl (estimated using E&P Tanks)
Oil tank Flash Gas	73.74 SCF/stock tank bbl (estimated using E&P Tanks)
Water tank W&B Losses	0.0131 SCF/stock tank bbl (using 1% of oil tank emissions)
Water tank Flash Gas	0.7374 SCF/stock tank bbl (using 1% of oil tank emissions)
VRU recovery efficiency	0.00%
Flare destruction efficiency	98.00%

Emission Point Summary

Emission Point Number	Emission Point Description	Design Capacity	Units	Operating Hours
AA-001	Flare	10.25	MMBtu/hr	8760
AA-001a	Flare Pilot	0.05	MMBtu/hr	8760
AA-002	Power Oil Pump Engine	165	hp	8760
AA-002a	Compressor Engine	215	hp	8760
AA-003	Fugitive emissions- equipment leaks	-	-	8760
AA-004	High Pressure Separator	-	-	8760
AA-005	Low Pressure Separator	-	-	8760
AA-006	Heater Treater	-	-	8760
AA-006a	Heater Treater (burner)	0.5	mmBtu/hr	8760
AA-007	Misc. Chemical Tanks	-	-	8760
AA-008	Oil and Water Storage Tanks	-	-	8760
AA-009	Truck Loading	16000	gal/hr	As needed
AA-010	Line Heater	0.5	MMBtu/hr	8760

Note: Storage tanks, separators, and heater treater vent to the flare.

Proposed Annual Emissions, controlled

Emission Unit ID	Emission Unit	Annual Emissions, tpy										GHG Emissions, tpy				
		PM	PM10	PM2.5	VOC	NOx	CO	SO2	Total HAPs	CO2	CH4	N2O	CO2e			
AA-001	Flare	0.34	0.34	0.34	43.83	12.29	56.04	0.00	6.7195	22362.21	91.78	0.04	24668.14			
AA-001a	Flare Pilot	0.00	0.00	0.00	0.00	0.02	0.02	0.00	0.0004	25.59	0.00	0.00	25.62			
AA-002	Power Oil Pump Engine	0.051	0.104	0.104	0.16	11.83	19.91	0.003	0.1735	624.23	0.03	0.00	625.26			
AA-002a	Compressor Engine	0.066	0.135	0.135	0.09	6.78	25.94	0.002	0.2261	813.39	0.01	0.00	814.14			
AA-003	Fugitive emissions- equipment leaks	-	-	-	0.26	-	-	-	0.0134	0.03	0.02	0.00	0.41			
AA-004	High Pressure Separator	Gas routed to Flare														
AA-005	Low Pressure Separator	Gas routed to Flare														
AA-006	Heater Treater	Gas routed to Flare														
AA-006a	Heater Treater (burner)	0.00408	0.01632	0.01632	0.01181	0.21471	0.18035	0.00129	0.0041	255.45	0.00	0.00	255.71			
AA-010	Line heater	0.00408	0.01632	0.01632	0.01181	0.21471	0.18035	0.00129	0.0041	255.45	0.00	0.00	255.71			
AA-007	Misc. Chemical Tanks (4)	-	-	-	0.02	-	-	-	0.0190	-	-	-	-			
AA-008	Oil and Water Tanks (4)	Gas routed to flare														
AA-009	Truck Loading	-	-	-	19.55	-	-	-	0.8747	0.05	0.29	0	7.28			
	Totals	0.46	0.61	0.61	63.93	31.35	95.00	0.01	8.0347	24336.41	92.13	0.04	26652.27			

Notes:
 Storage tanks emissions are included in flare emissions.

Potential Annual Emissions, uncontrolled

Emission Unit ID	Emission Unit	Annual Emissions, tpy										GHG Emissions, tpy					
		PM	PM10	PM2.5	VOC	NOx	CO	SO2	Total HAPs	CO2	CH4	N2O	CO2e				
AA-001	Facility gas emissions	-	-	-	2191.65	-	-	-	-	-	-	-	335.97	367.93	4580.52	0.00	114880.85
AA-002	Power Oil Pump Engine	0.051	0.104	0.104	0.16	11.83	19.91	0.003	0.003	0.003	0.003	0.17	0.17	624.23	0.01	0.00	624.88
AA-002a	Compressor Engine	0.066	0.135	0.135	0.21	15.41	25.94	0.004	0.004	0.004	0.004	0.23	0.23	813.39	0.02	0.00	814.23
AA-003	Fugitive emissions- equipment leaks	-	-	-	0.26	-	-	-	-	-	-	0.01	0.01	0.03	0.32	0.00	8.00
AA-004	High Pressure Separator		Gas routed to Flare														
AA-005	Low Pressure Separator		Gas routed to Flare														
AA-006	Heater Treater		Gas routed to Flare														
AA-006a	Heater Treater (burner)	0.00	0.02	0.02	0.01	0.21	0.18	0.00	0.00	0.00	0.00	0.0041	0.0041	232.23	0.00	0.00	232.47
AA-010	Line heater	0.00	0.02	0.02	0.01	0.21	0.18	0.00	0.00	0.00	0.00	0.0041	0.0041	232.23	0.00	0.00	232.47
AA-007	Misc. Chemical Tanks	-	-	-	0.02	-	-	-	-	-	-	0.02	0.02	-	-	-	-
AA-008	Oil and Water Storage Tanks		Gas routed to flare														
AA-009	Truck Loading				19.55							0.8747	0.8747	0.05	0.29	0	7.28
	Totals	0.13	0.27	0.27	2211.87	27.67	46.21	0.01	0.01	0.01	46.21	337.29	337.29	2270.09	4581.16	0.00	116800.17

Notes:
 Storage tanks emissions are included in flare emissions, AA-001.

Facility Maximum Hourly Emissions, Controlled

Emission Unit ID	Emission Unit	Emissions, lb/hr										GHG Emissions, lb/hr				
		PM	PM10	PM2.5	VOC	NOx	CO	SO2	Total HAPs	CO2	CH4	N2O	CO2e			
AA-001	Flare	0.08	0.08	0.08	10.01	2.81	12.80	0.00	1.53	5105.53	20.95	0.01	5631.99			
AA-001a	Flare Pilot	0.00	0.00	0.00	0.00	0.00	0.00	0.00	0.00	5.84	0.00	0.00	5.85			
AA-002	Power Oil Pump Engine	0.01	0.02	0.02	0.04	2.70	4.55	0.00	0.04	142.52	0.01	0.00	142.75			
AA-002a	Compressor Engine	0.02	0.03	0.03	0.05	3.52	5.92	0.00	0.05	185.71	0.00	0.00	185.90			
AA-003	Fugitive emissions- equipment leaks	-	-	-	0.06	-	-	-	0.00	0.01	0.00	0.00	0.09			
AA-004	High Pressure Separator	GAS ROUTED TO FLARE														
AA-005	Low Pressure Separator	GAS ROUTED TO FLARE														
AA-006	Heater Treater	GAS ROUTED TO FLARE														
AA-006a	Heater Treater (burner)	0.00	0.00	0.00	0.00	0.05	0.04	0.00	0.00	58.32	0.00	0.00	58.38			
AA-010	Line Heater	0.00	0.00	0.00	0.00	0.05	0.04	0.00	0.00	58.32	0.00	0.00	58.38			
AA-007	Misc. Chemical Tanks	-	-	-	0.00	-	-	-	0.00	-	-	-	0.00			
AA-008	Oil and Water Storage Tanks	GAS ROUTED TO FLARE														
AA-009	Truck Loading	-	-	-	117.72	-	-	-	5.27	0.01	0.07	0	1.66			
	Totals	0.11	0.14	0.14	127.88	9.13	23.35	0.002	6.90	5556.26	21.04	0.01	6085.01			

Notes:

Storage tanks emissions are included in flare emissions.

Truck loading hourly emissions are dictated by the capacity of the transfer pump

4.38 tpy = 1 PPH

Flash Gas Analysis and Conversions

Component	VOC and/or HAP?	Mol %	Wt %
Total S	None	***	0.00000%
CO2	None	0.362%	0.160%
N2	None	0.000%	0.000%
Methane	None	11.546%	1.852%
Ethane	None	6.480%	1.949%
Propane	VOC	19.755%	8.712%
Isobutane	VOC	20.171%	11.724%
Butane	VOC	12.576%	7.309%
Isopentane	VOC	9.194%	6.633%
Pentane	VOC	5.953%	4.295%
Hexane	VOC	3.906%	3.366%
Heptanes	VOC	6.630%	6.644%
Benzene	VOC and HAP	0.390%	0.544%
Toluene	VOC and HAP	0.388%	0.639%
e-Benzene	VOC and HAP	0.015%	0.028%
Xylenes	VOC and HAP	0.211%	0.400%
n-hexane	VOC and HAP	2.422%	3.726%
Total VOC		79.190%	54.020%
Total HAP		3.426%	5.337%

Heat of combustion, Btu/ft ³	2465.9
Molecular weight	46.02

Gas analysis generated by E&P Tanks software.

Produced Gas Analysis and Conversions

Component	VOC and/or HAP?	Mol %	Wt %
Total S	None	0.000%	0.00000%
CO2	None	2.312%	4.638%
N2	None	1.122%	1.433%
Methane	None	78.974%	57.752%
Ethane	None	9.069%	12.431%
Propane	VOC	3.555%	7.146%
Isobutane	VOC	0.815%	2.159%
Butane	VOC	1.407%	3.728%
Isopentane	VOC	0.550%	1.809%
Pentane	VOC	0.568%	1.868%
Hexane	VOC	0.960%	3.771%
n-Hexane	VOC and HAP	0.136%	0.565%
Heptanes+	VOC	0.472%	2.265%
Benzene	VOC and HAP	0.042%	0.051%
Toluene	VOC and HAP	0.010%	0.039%
e-Benzene	VOC and HAP	0.001%	0.004%
Xylenes	VOC and HAP	0.007%	0.020%
Total VOC		8.523%	23.746%
Total HAP		0.196%	0.679%

Heat of combustion, Btu/ft ³	1236.0
Molecular weight	21.94

TANK W & B GAS COMPOSITION

Component	VOC and/or HAP?	Mol %	Wt %
Total S	None	0.000%	0.00000%
CO2	None	0.32%	0.25%
N2	None	0.00%	0.00%
Methane	None	4.76%	1.35%
Ethane	None	7.23%	3.86%
Propane	VOC	24.31%	19.03%
Isobutane	VOC	23.60%	24.34%
Butane	VOC	14.17%	14.62%
Isopentane	VOC	9.38%	12.01%
Pentane	VOC	5.77%	7.39%
Hexane	VOC	3.28%	5.02%
Heptanes+	VOC	4.52%	8.03%
Benzene	VOC and HAP	0.32%	0.44%
Toluene	VOC and HAP	0.27%	0.44%
e-Benzene	VOC and HAP	0.01%	0.02%
Xylenes	VOC and HAP	0.12%	0.23%
n-hexane		1.95%	2.98%
Total VOC		85.75%	91.56%
Total HAP		2.660%	4.10%

44.1 0.140414
 28.01 0
 16.04 0.762878
 30.07 2.174783
 44.1 10.72005
 58.12 13.71649
 58.12 8.235546
 72.15 6.766083
 72.15 4.163055
 86.18 2.8286
 100.21 4.526586
 78.11 0.247531
 92.14 0.245092
 106.17 0.009449
 106.16 0.129091
 86.18 1.677235
 56.34289

0.874735

Heat of combustion, Btu/ft ³	2796.8
Molecular weight	51.43

Note: W&B vapors and truck loading vapors assumed to have same composition
 Gas analysis generated by E&P Tanks software.

Tank Uncontrolled Emissions Summary

	Potential	Initial Production
Total flash gas ,	9,422,977	1,076
Total flash gas ,	559.83	127.82
Total tank W&B loss	167,400	19
Total tank W &B losses	11.11	2.54
Total tank emissions	570.95	130.35
Tank emissions to flare	570.95	130.35

Notes:

1. Total flash gas calculated using gas/oil ratio from E&P tanks program and potential crude and water production
2. All tank emissions included with flare, Emission Point AA-001.

**Calculation of Criteria and Hazardous Flare Emissions
Using Average Production Values**

Gas Flow to Flare:

Flow to flare of tank flash gas	=	Potential
Flow to flare of tank W&B emissions	=	559.83 tpy
Flow to flare from truck loading	=	11.11 tpy
Total process gas to flare	=	0.00 tpy
Produced gas to flare	=	570.95 tpy
	=	7913.14 tpy
	=	273750.00 mcf/yr

Produced gas combustion heat	=	3388355.00 MMBtu/yr
process gas combustion heat	=	23220.18 MMBtu/yr
flare gas combustion heat, total	=	361575.18 MMBtu/yr

Calculation	Pollutant	Emission factor, lbs/MMBtu	Potential Emissions		Pollutant	Potential Emissions	
			lb/hr	tpy		lb/hr	tpy
	NOx	0.068	2.807	12.294	n-hexane	1.4512	6.3562
	CO	0.31	12.795	56.044	benzene	0.0326	0.1426
	PM	0.00186	0.005	0.336	e-benzene	0.0022	0.0096
	VOC	mass balance	10.008	43.833	toluene	0.0306	0.1342
	SO ₂	mass balance	0.000	0.000	xylenes	0.0176	0.0769
	PM10/PM2.5	0.00745	0.308	1.347	Total HAPs	1.5341	6.7195

Notes:

1. Emission factors from AP-42, Table 13.5-1, are used to calculate NOx and CO emissions, and PM emission factor from AP-42, Table 1.4-2.
 2. Mass balance calculations utilize flare input gas flow and a flare destruction efficiency of 98% minimum.
 3. Mass balance for sulfur assumes all sulfur converted to SO₂ in flare.
- ank Battery HAP emissions calculated using mass balance and 98% destruction efficiency
Oil General Permit Coverage Application

**Calculation of Maximum Hourly Criteria and Hazardous Flare Emissions
 Using Initial Production Values**

Gas Flow to Flare:

Flow to flare of tank flash gas	=	Potential
Flow to flare of tank W&B emissions	=	127.82 lbs/hr
Flow to flare from truck loading	=	2.54 lbs/hr
Total process gas to flare	=	0.00 lbs/hr
Produced gas to flare	=	130.35 lbs/hr
	=	1806.65 lbs/hr
	=	31.25 mcf/hr
Produced gas combustion heat	=	38.63 MMBtu/hr
process gas combustion heat	=	2.65 MMBtu/hr
flare gas combustion heat, total	=	41.28 MMBtu/hr

Calculation	Pollutant	Emission factor, lbs/MMBtu	Maximum Hourly Emissions		Potential Emissions
			lb/hr	Pollutant	
NOx		0.068	2.807	n-hexane	1.4512
CO		0.37	15.272	benzene	0.0326
PM		0.00745	0.308	e-benzene	0.0022
VOC		mass balance	10.008	toluene	0.0306
SO ₂		mass balance	0.000	xylenes	0.0176
				Total HAPs	1.5341

Notes:

1. Emission factors from AP-42, Table 13.5-1, are used to calculate NOx and CO emissions, and PM emission factor from AP-42, Table 1.4-2.
2. Mass balance calculations utilize flare input process gas flow and a flare destruction efficiency of 98% minimum.
3. Mass balance for sulfur assumes all sulfur converted to SO₂ in flare.
4. HAP emissions calculated using mass balance and 98% destruction efficiency

Calculation of Uncontrolled Emissions of Produced Gas

Flow to flare from tank flash gas	=	Potential
Flow to flare from tank W&B emissions	=	559.83 tpy
flow to flare from truck loading	=	11.11
Produced gas to flare from separators	=	0.00 tpy
	=	7913.14 tpy

<u>Pollutant</u>	<u>Emission factor, lbs/MMBtu</u>	<u>lb/hr</u>	<u>Potential Emissions tpy</u>
VOC	mass balance	500.378	2191.65
H2S	mass balance	0.000	0.00
n-hexane	mass balance	72.559	317.81
benzene	mass balance	1.628	7.13
e-benzene	mass balance	0.109	0.48
toluene	mass balance	1.532	6.71
xylenes	mass balance	0.878	3.85
total HAPs	mass balance	76.706	335.97
methane	mass balance	1045.780	4580.52
CO2	mass balance	84.003	367.93

Note: For calculation of uncontrolled emissions, flare efficiency is 0%.

Calculation of Flare GHG Emissions

Process gas to flare, mmcf/yr 9.42
 N2O emission factor, kg/mm8tu 0.0001
 HHV, mm8tu/scf 0.001235
 CO2 density, kg/ft3 0.052600
 CH4 density, kg/ft3 0.019200
 flare efficiency 98.00%

PROCESS GAS

carbon atoms	CO2 (from combustion)		CO2 input tpy	CH4, uncombusted		N2O tpy ¹	CO2e tpy
	cubic ft.	tpy		cubic ft.	tpy ¹		
1	1.07E+06	6.17E+01	1.97E+00	2.17E+04	4.59E-01	1.28E-03	1.38E+01
2	1.20E+06	6.92E+01	*				6.17E+01
3	5.47E+06	3.16E+02					6.92E+01
4	1.21E+07	6.99E+02					3.16E+02
5+	1.23E+07	7.12E+02					6.99E+02
Total	3.21E+07	1.86E+03	1.97E+00	2.17E+04	4.59E-01	1.28E-03	7.12E+02

PRODUCED GAS

273.75

produced gas to flare, mmcf/yr

carbon atoms	CO2 (from combustion)		CO2 input tpy	CH4, uncombusted		N2O tpy	CO2e tpy
	cubic ft.	tpy		cubic ft.	tpy		
1	2.12E+08	1.23E+04	3.66E+02	4.32E+06	9.13E+01	3.72E-02	2.66E+03
2	4.87E+07	2.82E+03					1.23E+04
3	2.86E+07	1.66E+03					2.82E+03
4	2.38E+07	1.38E+03					1.66E+03
5+	3.50E+07	2.03E+03					1.38E+03
Total	3.48E+08	2.01E+04	3.66E+02	4.32E+06	9.13E+01	3.72E-02	2.03E+03

Note: GHG emissions calculated using procedures from 40 CFR 98.233(n)(4)

Equipment Component Fugitive Emissions

Components	Counts	Emission Factor ¹ scf/hr/component	Emissions lbs/hr	Wt. Fraction VOC	VOC Emissions		VOC% HAP ³	HAP Emissions		GHG Emissions, ton/yr		
					lb/hr	tpy		lb/hr	tpy	CO ₂	CH ₄	CO ₂ e
Valves:	37											
gas/vapor	24	0.027	0.037462767	0.24	0.009	0.04	0.68%	0.000	0.001	0.007596	0.09468	2.37
light oil ²	13	0.05	0.037578393	0.54	0.020	0.09	5.34%	0.002	0.009	0.00762	0.086338	2.17
heavy oil	0	0.0005	0	0.24	0.000	0.00	0.68%	0.000	0.000	0	0	0.00
Pumps:												
Light oil	0	0.01	0	0.73	0.000	0.00	1.66%	0.000	0.000	0	0	0.00
heavy oil	0	0	0	0.24			0.68%	0.000	0.000	0	0	0.00
Flanges:	46											
gas/vapor		0	0	0.24			0.68%	0.000	0.000	0	0	0.00
light oil	46	0.003	0.007978182	0.73	0.006	0.03	1.66%	0.000	0.001	0.001618	0.01833	0.46
heavy oil	0	0.0009	0	0.24	0.000	0.00	0.68%	0.000	0.000	0	0	0.00
Relief Valve:												
gas/vapor	4	0.04	0.009250066	0.24	0.002	0.01	0.68%	0.000	0.000	0.001876	0.021252	0.53
Connectors:	101											
gas/vapor	67	0.003	0.011620395	0.24	0.003	0.01	0.68%	0.000	0.000	0.002356	0.026698	0.67
light oil	34	0.007	0.013759473	0.73	0.010	0.04	1.66%	0.000	0.001	0.00279	0.031613	0.79
heavy oil	0	0.0003	0	0.24	0.000	0.02	0.68%	0.000	0.000	0	0	0.00
Other	1	0.3	0.017343874	0.24	0.004	0.02	1.66%	0.000	0.001	0.003517	0.039848	1.00
Totals					0.054	0.255		0.003	0.013	0.027	0.319	7.996

Notes:

- Emission factors and equipment counts taken from 40 CFR 98, subpart W.
- Light oil is defined as having API gravity greater than or equal to 20 degrees API.
- Vapors emitted from gas service equipment assumed to be same as produced gas, vapor from liquid service equipment assumed to be the same as flash gas.

Equipment	Count	Valves	Flanges	Fittings	prv	Other
wellhead	1	5	10	4		0
heater treater	1	8	12	20		0
header	0	0	0	0		0
separator	2	12	24	20		0
meters/piping	0	0	0	0		0
compressor	1	12	0	57		4
dehydrator	0	0	0	0		0
total		37	46	101		4

	tpy
n-hexane	0.07423
benzene	0.00100
ethyl benzene	0.00008
toluene	0.00077
xylene	0.00039

ENGINE POTENTIAL EMISSIONS CALCULATIONS

Engine No.	HP	Heat Input mmBtu/hr	Emissions, tpy										GHG Emissions, tons/yr		
			NOx	VOC	CO	SO2	TSP	PM10	PM2.5	CO2	CH4	N2O	CO2e		
AA-002	165	1.22	11.83	0.16	19.91	0.00	0.05	0.10	0.10	0.10	0.10	624.23	1.18E-02	0.001	624.88
AA-002a	215	1.59	15.41	0.21	25.94	0.00	0.07	0.14	0.14	0.14	0.14	813.39	1.53E-02	0.002	814.23
		Total	27.24	0.36	45.85	0.01	0.12	0.24	0.24	0.24	0.24	1437.62	0.03	0.00	1439.11

AP-42

Pollutant	Emission Factor lbs/MMBtu
NOx	2.21
VOC	0.0296
CO	3.72
SO2	0.000588
PM10	0.00950
PM2.5	0.00950
PM cond	0.00991

Conversion Factor, g to lbs
 0.0022046

GHG Emission Factors
 kg/mmBtu

CO2	53.02
CH4	0.001
N2O	0.0001

ENGINE HAP EMISSIONS CALCULATIONS

HAP	Natural Gas Emission Factor, lbs/mmBtu	AA-002 HAP EMISSIONS		AA-002a HAP EMISSIONS		Total HAP Emissions tpy
		lbs/hr	tpy	lbs/hr	tpy	
1,1,2,2-Tetrachloroethane	2.53E-05	3.09E-05	1.35E-04	4.03E-05	1.76E-04	3.12E-04
1,1,2-Trichloroethane	1.53E-05	1.87E-05	8.19E-05	2.44E-05	1.07E-04	1.89E-04
1,3-Butadiene	6.63E-04	8.10E-04	3.55E-03	1.06E-03	4.62E-03	8.17E-03
1,3-Dichloropropene	1.27E-05	1.55E-05	6.80E-05	2.02E-05	8.86E-05	1.57E-04
Acetaldehyde	2.79E-03	3.41E-03	1.49E-02	4.44E-03	1.95E-02	3.44E-02
Acrolein	2.63E-03	3.21E-03	1.41E-02	4.19E-03	1.83E-02	3.24E-02
Benzene	1.58E-03	1.93E-03	8.46E-03	2.52E-03	1.10E-02	1.95E-02
Carbon Tetrachloride	1.77E-05	2.16E-05	9.47E-05	2.82E-05	1.23E-04	2.18E-04
Chlorobenzene	1.29E-05	1.58E-05	6.90E-05	2.05E-05	9.00E-05	1.59E-04
Chloroform	1.37E-05	1.67E-05	7.33E-05	2.18E-05	9.55E-05	1.69E-04
Ethylbenzene	2.48E-05	3.03E-05	1.33E-04	3.95E-05	1.73E-04	3.06E-04
Ethylene Dibromide	2.13E-05	2.60E-05	1.14E-04	3.39E-05	1.49E-04	2.63E-04
Formaldehyde	2.05E-02	2.50E-02	1.10E-01	3.26E-02	1.43E-01	2.53E-01
Methanol	3.06E-03	3.74E-03	1.64E-02	4.87E-03	2.13E-02	3.77E-02
Methylene Chloride	4.12E-05	5.03E-05	2.20E-04	6.56E-05	2.87E-04	5.08E-04
Naphthalene	9.71E-05	1.19E-04	5.20E-04	1.55E-04	6.77E-04	1.20E-03
PAH	1.41E-04	1.72E-04	7.55E-04	2.24E-04	9.83E-04	1.74E-03
Styrene	1.19E-05	1.45E-05	6.37E-05	1.89E-05	8.30E-05	1.47E-04
Toluene	5.58E-04	6.82E-04	2.99E-03	8.88E-04	3.89E-03	6.88E-03
Vinyl Chloride	7.18E-06	8.77E-06	3.84E-05	1.14E-05	5.01E-05	8.85E-05
Xylene	1.95E-04	2.38E-04	1.04E-03	3.10E-04	1.36E-03	2.40E-03
Total		3.96E-02	1.73E-01	5.16E-02	2.26E-01	4.00E-01

AA-002 heat input= 1.22 mmBtu/hr

AA-002a heat input= 1.59 mmBtu/hr

annual operating hours= 8760

Emission factors from AP-42, Table 3.2-3

Truck Loading Emissions Calculations 30-Day Average production

Basis: 30 day average production rates
 $L_L = 12.46 \cdot (SPM)/T$ (from EPA AP-42 Section 5.2.2.1)

Where:

- L_L = Loading loss, lbs per 1,000 gal of liquid loaded
- S = Saturation factor
- P = True vapor pressure of liquid, psia
- M = Molecular weight of vapors, lb/lb-mole
- T = Temperature of bulk liquid loaded, degrees R

CRUDE OIL

EPA "S" Factor	True VP of Liquid (psia)	Mol. Wt. Of Vapors (lb/lb-mole)	Temp. of Liquid (R)	Sales Volume (10^3 gal/yr)	Loading Rate (gal/hr)	Uncontrolled Estimated Emissions, Total Hydrocarbons (L_L (lb/hr))	Uncontrolled Estimated Emissions, Total Hydrocarbons (tpy)
1.45	5	48.00	545	5,366	16,000	7.96	21.34

PRODUCED WATER

EPA "S" Factor	True VP of Liquid (psia)	Mol. Wt. Of Vapors (lb/lb-mole)	Temp. of Liquid (R)	Loaded Volume (10^3 gal/yr)	Loading Rate (gal/hr)	Uncontrolled Estimated Emissions, Total Hydrocarbons (L_L (lb/hr))	Uncontrolled Estimated Emissions, Total Hydrocarbons (tpy)
1.45	0.05	48.00	545	153	16,000	0.08	0.01

Calculation

HAPs	tons/yr
Benzene	0.093798
Toluene	0.092874
m-Benzene	0.003581
Xylenes	0.048917
n-hexane	0.635565
	0.874735

Truck Loading Emissions Calculations, Maximum lbs/hr

$L_L = 12.46 * (SPM)/T$ (from EPA AP-42 Section 5.2.2.1)

Where:

- L_L = Loading loss, lbs per 1,000 gal of liquid loaded
- S = Saturation factor
- P = True vapor pressure of liquid, psia
- M = Molecular weight of vapors, lb/lb-mole
- T = Temperature of bulk liquid loaded, degrees R

CRUDE OIL

EPA "S" Factor	True VP of Liquid (psia)	Mol. Wt. Of Vapors (lb/lb-mole)	Temp. of Liquid (R)	Sales Volume (10 ³ gal/hr)	Loading Rate (gal/hr)	Uncontrolled Estimated Emissions, Total Hydrocarbons L _L (lb/hr)
1.45	5	48.00	545	16.0	16,000	127.30

PRODUCED WATER

EPA "S" Factor	True VP of Liquid (psia)	Mol. Wt. Of Vapors (lb/lb-mole)	Temp. of Liquid (R)	Loaded Volume (10 ³ gal/hr)	Loading Rate (gal/hr)	Uncontrolled Estimated Emissions, Total Hydrocarbons L _L (lb/hr)
1.45	0.05	48.00	545	16.0	16,000	0.08

Calculation

HAPS	lbs/hr
Benzene	0.564848
Toluene	0.559285
e-Benzene	0.021562
Xylenes	0.294576
n-hexane	3.82734
total	5.267611

External Combustion Equipment Emissions Calculations

Source	Capacity MMBtu/hr	Emissions, tons/yr										GHG Emissions, metric tons/yr			
		PM	PM10	PM 2.5	NOx	CO	VOC	SO2	HAP	CO2	CH4	N2O	CO2e		
Heater Tre	0.5	0.004	0.016	0.016	0.215	0.180	0.012	0.001	0.004	255.45	0.00	0.00	255.72		
Line Heate	0.5	0.004	0.016	0.016	0.215	0.180	0.012	0.001	0.000	255.45	0.00	0.00	255.72		
Totals		0.008	0.033	0.033	0.429	0.361	0.024	0.003	0.004	510.90	0.01	0.00	511.44		

Ap-42 natural gas combustion

Emission Factors, lbs/MMBtu	
Pm	0.001863
PM10	0.007451
PM2.5	0.007451
NOx	0.098039
CO	0.082353
VOC	0.005392
SO2	0.000588
HAPs	0.001851

40 CFR 98, subpart C

Emission Factors, kg/MIMBtu	
CO2	53.02
CH4	0.001
N2O	0.0001

Natural Gas Combustion HAP Calculations

HAP	Natural Gas Emission Factor, lbs/mmBtu	Heater Treater HAP EMISSIONS		Flare Pilot HAP EMISSIONS		Line Heater HAP EMISSIONS	
		lbs/hr	tpy	lbs/hr	tpy	lbs/hr	tpy
Benzene	2.06E-06	1.03E-06	4.51E-06	1.03E-07	4.51E-07	1.03E-06	4.51E-06
Dichlorobenzene	1.18E-06	5.88E-07	2.58E-06	5.88E-08	2.58E-07	5.88E-07	2.58E-06
Formaldehyde	7.35E-05	3.68E-05	1.61E-04	3.68E-06	1.61E-05	3.68E-05	1.61E-04
Hexane	1.76E-03	8.82E-04	3.86E-03	8.82E-05	3.86E-04	8.82E-04	3.86E-03
Naphthalene	5.98E-07	2.99E-07	1.31E-06	2.99E-08	1.31E-07	2.99E-07	1.31E-06
Polycyclic Organic Matter	2.38E-05	1.19E-05	5.21E-05	1.19E-06	5.21E-06	1.19E-05	5.21E-05
Toluene	3.33E-06	1.67E-06	7.30E-06	1.67E-07	7.30E-07	1.67E-06	7.30E-06
Total		9.35E-04	4.09E-03	9.35E-05	4.09E-04	9.35E-04	4.09E-03

Burner Heat Input= 0.50 mmBtu/hr
Flare Pilot Heat Input= 0.05 mmBtu/hr
Line Heater Heat Input= 0.50
annual operating hours= 8760
Emission factors from AP-42, Table 1.4-3

FLARE PILOT CALCULATIONS

Emission Unit ID	Combustion Source	Capacity MMBTUH	Criteria Emissions, tons/yr							
			PM	PM10	PM2.5	NOx	CO	VOC	SO2	HAP
AA-001a	Flare (Pilot)	0.05	0.000	0.002	0.002	0.021	0.018	0.001	0.000	0.000

Emission Unit ID	Combustion Source	Capacity MMBTUH	GHG Emissions, metric tons/yr			GHG Emissions, short tons/yr				
			CO2	CH4	N2O	CO2e	CH4	N2O	CO2e	
AA-001a	Flare (Pilot)	0.05	23.223	0.000	0.000	23.246	25.59	0.00	0.00	25.62

Gas combustion

AP-42 Emission Factors, lbs/MMBtu		Emission Factors, kg/MMBtu	
TSP	0.001863	CO2	53.02
PM10	0.007451	CH4	0.001
PM2.5	0.007451	N2O	0.0001
NOx	0.098039		
CO	0.082353		
VOC	0.005392		
SO2	0.000588		
HAPs	0.001851		

**APPENDIX B:
BACKUP DOCUMENTATION**

TANKS 4.0.9d
Emissions Report - Summary Format
Tank Identification and Physical Characteristics

Identification
 User Identification: Anti-Foam Tank Stringer
 City: Mississippi
 State: Mississippi
 Company: Venture Oil
 Type of Tank: Horizontal Tank
 Description: 250-Gallon Anti-Foam Tank

Tank Dimensions
 Shell Length (ft): 5.00
 Diameter (ft): 5.00
 Volume (gallons): 250.00
 Turnovers: 1.46
 Net Throughput(gal/yr): 365.00
 Is Tank Heated (y/n): N
 Is Tank Underground (y/n): N

Paint Characteristics
 Shell Color/Shade: White/White
 Shell Condition: Good

Breather Vent Settings
 Vacuum Settings (psig): -0.03
 Pressure Settings (psig): 0.03

Meteorological Data used in Emissions Calculations: Jackson, Mississippi (Avg Atmospheric Pressure = 14.59 psia)

TANKS 4.0.9d
Emissions Report - Summary Format
Liquid Contents of Storage Tank

Anti-Foam Tank - Horizontal Tank Stringer, Mississippi

Mixture/Component	Month	Daily Liquid Surf. Temperature (deg F)		Vapor Pressure (psia)	Vapor Pressure (psia)	Vapor Mol. Weight	Liquid Mass Fract.	Vapor Mass Fract.	Mol. Weight	Basis for Vapor Pressure Calculations
		Avg.	Max.							
Toluene	All	65.19	80.06	72.32	0.3992	0.3307	0.4799	92.1900	92.19	Option 2: A=4.954, B=1344.8, C=219.48

TANKS 4.0.9d
Emissions Report - Summary Format
Individual Tank Emission Totals

Emissions Report for: Annual

Anti-Foam Tank - Horizontal Tank Stringer, Mississippi

Components	Losses(lbs)		Total Emissions
	Working Loss	Breathing Loss	
Toluene	0.32	7.47	7.79

TANKS 4.0.9d
Emissions Report - Summary Format
Tank Identification and Physical Characteristics

Identification
 User Identification: Corrosion Inhibitor Tank
 City: Stringer
 State: Mississippi
 Company: Venture Oil
 Type of Tank: Horizontal Tank
 Description: 55-Gallon Corrosion Inhibitor Drum(s)

Tank Dimensions
 Shell Length (ft): 5.00
 Diameter (ft): 3.00
 Volume (gallons): 55.00
 Turnovers: 20.00
 Net Throughput(gal/yr): 1,095.00
 Is Tank Heated (y/n): N
 Is Tank Underground (y/n): N

Paint Characteristics
 Shell Color/Shade: White/White
 Shell Condition: Good

Breather Vent Settings
 Vacuum Settings (psig): -0.03
 Pressure Settings (psig): 0.03

Meteorological Data used in Emissions Calculations: Jackson, Mississippi (Avg Atmospheric Pressure = 14.59 psia)

TANKS 4.0.9d
Emissions Report - Summary Format
Liquid Contents of Storage Tank

Corrosion Inhibitor Tank - Horizontal Tank
Stringer, Mississippi

Mixture/Component	Month		Daily Liquid Surf. Temperature (deg F)		Liquid Bulk Temp (deg F)	Vapor Pressure (psia)		Vapor Mol. Weight		Liquid Mass Fract.	Vapor Mass Fract.	Mol. Weight	Basis for Vapor Pressure Calculations
	Avg	Max	Avg	Max		Min	Max	Min	Max				
Toluene	66.19	60.06	72.32	64.24	64.24	0.3962	0.3307	0.4793	92.1300			92.13	Option 2 A=6.954, B=1344.8, C=219.48

TANKS 4.0.9d
Emissions Report - Summary Format
Individual Tank Emission Totals

Emissions Report for: Annual
Corrosion Inhibitor Tank - Horizontal Tank
Stringer, Mississippi

Components	Losses (lbs)		Total Emissions
	Working Loss	Breathing Loss	
Toluene	0.96	2.74	3.70

TANKS 4.0.9d
Emissions Report - Summary Format
Tank Identification and Physical Characteristics

Identification
 User Identification: Emulsion Breaker Tank
 City: Stringer
 State: Mississippi
 Company: Venture Oil
 Type of Tank: Horizontal Tank
 Description: 250-Gallon Emulsion Breaker Tank

Tank Dimensions
 Shell Length (ft): 5.00
 Diameter (ft): 5.00
 Volume (gallons): 250.00
 Turnovers: 2.92
 Net Throughput(gal/yr): 730.00
 Is Tank Heated (y/n): N
 Is Tank Underground (y/n): N

Paint Characteristics
 Shell Color/Shade: White/White
 Shell Condition: Good

Breather Vent Settings
 Vacuum Settings (psig): -0.03
 Pressure Settings (psig): 0.03

Meteorological Data used in Emissions Calculations: Jackson, Mississippi (Avg Atmospheric Pressure = 14.59 psia)

TANKS 4.0.9d
Emissions Report - Summary Format
Liquid Contents of Storage Tank

Emulsion Breaker Tank - Horizontal Tank
 Stringer, Mississippi

Mixture/Component	Month	Daily Liquid Surf. Temperature (deg F)		Vapor Pressure (psia)		Vapor Mol. Weight		Liquid Mass Fract.		Vapor Mass Fract.		Mol. Weight	Basis for Vapor Pressure Calculations
		Avg	Max.	Avg	Min.	Max.	Min.	Max.	Min.	Max.			
Toluene	All	68.19	60.06	72.32	64.24	0.3992	0.3307	0.4793	92.1900	92.19	92.19	Option 2 A=6.954, B=1344.8, C=219.48	

TANKS 4.0.9d
Emissions Report - Summary Format
Individual Tank Emission Totals

Emissions Report for: Annual
 Emulsion Breaker Tank - Horizontal Tank
 Stringer, Mississippi

Components	Losses(lbs)		Total Emissions
	Working Loss	Breathing Loss	
Toluene	0.64	7.47	8.11

TANKS 4.0.9d
Emissions Report - Summary Format
Tank Identification and Physical Characteristics

Identification

User Identification: Methanol Tank
 City: Stringer
 State: Mississippi
 Company: Venture Oil
 Type of Tank: Horizontal Tank
 Description: 330-Gallon Methanol Tank

Tank Dimensions

Shell Length (ft): 5.00
 Diameter (ft): 5.00
 Volume (gallons): 330.00
 Turnovers: 2.21
 Net Throughput(gal/yr): 730.00
 Is Tank Heated (y/n): N
 Is Tank Underground (y/n): N

Paint Characteristics

Shell Color/Shade: White/White
 Shell Condition: Good

Breather Vent Settings

Vacuum Settings (psig): -0.03
 Pressure Settings (psig): 0.03

Meteorological Data used in Emissions Calculations: Jackson, Mississippi (Avg Atmospheric Pressure = 14.59 psia)

TANKS 4.0.9d
Emissions Report - Summary Format
Liquid Contents of Storage Tank

Methanol Tank - Horizontal Tank
Stringer, Mississippi

Mixture/Component	Month	Avg.	Daily Liquid Surf. Temperature (deg F)		Vapor Pressure (psia)	Vapor Pressure (psia)	Vapor Pressure (psia)	Vapor Mol. Weight	Liquid Mass Fract.	Vapor Mass Fract.	Mol. Weight	Basis for Vapor Pressure Calculations
			Min.	Max.								
Methyl alcohol	All	66.19	60.06	72.32	1.7478	1.4448	2.1095	32.0400			32.04	Option 2: A=7.897, B=1474.08, C=229.13

TANKS 4.0.9d
Emissions Report - Summary Format
Individual Tank Emission Totals

Emissions Report for: Annual

Methanol Tank - Horizontal Tank
Stringer, Mississippi

Components	Losses(lbs)		Total Emissions
	Working Loss	Breathing Loss	
Methyl alcohol	0.97	17.15	18.13

Project Setup Information

Project File : Untitled.Ept
 Flowsheet Selection : Oil Tank with Separator
 Calculation Method : AP42
 Control Efficiency : 100.0%
 Known Separator Stream : Geographical Region
 Geographical Region : All Regions in US
 Entering Air Composition : No
 Well ID : Venture Jernigan 6-10 No. 1
 Date : 2019.01.08

Data Input

Separator Pressure : 45.00 [psig]
 Separator Temperature : 140.00 [F]
 Ambient Pressure : 14.70 [psia]
 Ambient Temperature : 140.00 [F]
 C10+ SG : 0.8930
 C10+ MW : 277.00

Low Pressure Oil

No.	Component	mol %
1	H2S	0.0000
2	O2	0.0000
3	CO2	0.0400
4	N2	0.0000
5	C1	1.2100
6	C2	0.7600
7	C3	2.9200
8	i-C4	4.1500
9	n-C4	3.0600
10	i-C5	3.9300
11	n-C5	3.0900
12	C6	4.9100
13	C7	13.0800
14	C8	14.6200
15	C9	7.6300
16	C10+	31.1400
17	Benzene	0.6900
18	Toluene	1.9400
19	E-Benzene	0.1900
20	Xylenes	2.9800
21	n-C6	3.6600
22	2,2,4-trimethylp	0.0000

Sales Oil

Production Rate : 218 [bbl/day]
 Days of Annual Operation : 365 [days/year]
 API Gravity : 47.0
 Reid Vapor Pressure : 6.00 [psia]
 Bulk Temperature : 80.00 [F]

Tank and Shell Data

Diameter : 21.00 [ft]
 Shell Height : 16.00 [ft]
 Cone Roof Slope : 0.06
 Average Liquid Height : 8.00 [ft]
 Vent Pressure Range : 0.06 [psi]
 Solar Absorbance : 0.39

Meteorological Data

City : Jackson, MS
 Ambient Pressure : 14.70 [psia]
 Ambient Temperature : 140.00 [F]
 Min Ambient Temperature : 52.70 [F]

Max Ambient Temperature : 76.30[F]
 Total Solar Insolation : 1409.00[Btu/ft^2*day]

 * Calculation Results *

--- Emission Summary ---

Item	Uncontrolled [ton/yr]	Uncontrolled [lb/hr]
Total HAPs	23.460	5.356
Total HC	437.788	99.952
VOCs, C2+	423.339	96.653
VOCs, C3+	407.954	93.140

Uncontrolled Recovery Info.
 Vapor [MSCFD] 16.3600
 HC Vapor [MSCFD] 16.3100
 GOR [SCF/bbl] 75.05

--- Emission Composition ---

No	Component	Uncontrolled [ton/yr]	Uncontrolled [lb/hr]
1	H2S	0.000	0.000
2	O2	0.000	0.000
3	CO2	1.257	0.287
4	N2	0.000	0.000
5	C1	14.448	3.299
6	C2	15.385	3.513
7	C3	68.917	15.734
8	i-C4	92.659	21.155
9	n-C4	57.728	13.180
10	i-C5	52.289	11.938
11	n-C5	33.828	7.723
12	C6	25.783	5.887
13	C7	33.003	7.535
14	C8	16.359	3.735
15	C9	3.924	0.896
16	C10+	0.002	0.000
17	Benzene	2.395	0.547
18	Toluene	2.803	0.640
19	E-Benzene	0.125	0.029
20	Xylenes	1.752	0.400
21	n-C6	16.388	3.742
22	2,2,4-Trimethylp	0.000	0.000
	Total	439.045	100.239

--- Stream Data ---

No.	Component	MMBtu	LP Oil	Flash Oil	Sale Oil	Flash Gas	W&S Gas	Total
1	H2S	34.80	0.0000	0.0000	0.0000	0.0000	0.0000	0.0000
2	O2	32.00	0.0000	0.0000	0.0000	0.0000	0.0000	0.0000
3	CO2	44.01	0.0400	0.0037	0.0021	0.3632	0.3184	0.3624
4	N2	28.01	0.0000	0.0000	0.0000	0.0000	0.0000	0.0000
5	C1	16.04	1.2100	0.0481	0.0134	11.5462	4.7561	11.4290
6	C2	30.07	0.7600	0.1170	0.0860	6.4800	7.2324	6.4930
7	C3	44.10	2.9200	1.0276	0.9354	19.7545	24.3085	19.8331
8	i-C4	58.12	4.1500	2.3490	2.2672	20.1714	23.6003	20.2306
9	n-C4	58.12	3.0600	1.9902	1.9437	12.5764	14.1699	12.6039
10	i-C5	72.15	3.9300	3.3383	3.3160	9.1937	9.3778	9.1969
11	n-C5	72.15	3.0900	2.7682	2.7574	5.9530	5.7777	5.9499
12	C6	86.16	4.9100	5.0229	5.0308	3.9060	3.2822	3.8952
	Page 2						E&P TANK	
13	C7	100.20	13.0800	14.0626	14.1081	4.3385	3.1381	4.3178
14	C8	114.23	14.6200	16.0518	16.1129	1.8828	1.1624	1.8703
15	C9	128.28	7.6300	8.4418	8.4755	0.4082	0.2166	0.4049
16	C10+	166.00	31.1400	34.6405	34.7819	0.0000	0.0000	0.0001
17	Benzene	78.11	0.6900	0.7237	0.7254	0.3904	0.3169	0.3891
18	Toluene	92.13	1.9400	2.1144	2.1221	0.3882	0.2660	0.3861

19	E-Benzene	106.17	0.1900	0.2097	0.2105	0.0150	0.0089	0.0149
20	Xylenes	106.17	2.9800	3.2913	3.3042	0.2110	0.1216	0.2094
21	n-C6	86.18	3.6600	3.7992	3.8073	2.4215	1.9462	2.4133
22	2,2,4-Trimethylp	114.24	0.0000	0.0000	0.0000	0.0000	0.0000	0.0000
MW		148.51	158.95	158.95	159.17	55.71	56.35	55.72
	Stream Mole Ratio	1.0000	0.8989	0.8972	0.8972	0.1011	0.0018	0.1028
	Heating Value	[BTU/SCF]				3108.39	3147.61	3109.06
	Gas Gravity	[Gas/Air]				1.92	1.95	1.92
	Bubble Pt. @ 100F	[psia]	59.52	10.16	8.49			
	RV2 @ 100F	[psia]	129.92	49.63	46.58			
	Spec. Gravity @ 100F		0.743	0.751	0.751			



DELBERT HOSEMANN
Secretary of State

This is not an official certificate of good standing.

Name History	
Name VENTURE OIL & GAS INC.	Name Type Legal
Business Information	
Business Type: Business ID: Status: Effective Date: State of Incorporation: Principal Office Address:	Profit Corporation 558492 Good Standing 11/07/1988 Mississippi
Registered Agent	
Name JAY DONALD FENTON 207 South 13th Avenue Laurel, MS 39440	
Officers & Directors	
Name Jay Donald Fenton 332 Luther Hill Road, A Ellisville, MS 39437	Title Incorporator
William Edward Carpenter 112 Westminister Drive Hattiesburg, MS 39401	Incorporator
Jay Donald Fenton 332 Luther Hill Rd Ellisville, MS 39437	Director, President
Neil Scrimshire 9 Heritage Trail Laurel, MS 39440	Director, Secretary, Vice President