

STORM WATER POLLUTION PREVENTION PLAN

FOR THE

THE CONSTRUCTION OF TREVOR TRAILS SUBDIVISION PROJECT

*WPA ROAD
LAMAR COUNTY, MISSISSIPPI*



*P.O. Box 1935 / Purvis, Mississippi 39475
Phone: (601) 794-4565 Email: hunter@andrewsengineering.net*

TABLE OF CONTENTS

SECTION	PAGE NO.
Table of Contents	1
I. Introduction	2
II. Site Assessment	2
A. Description of Work	2
B. Potential Pollution Sources	2
C. Non-Storm Water Discharges	2
D. Non-Storm Water Solid Materials	2
E. Drainage Patterns	2
F. Receiving Waters	3
III. Best Management Practices	3
A. General	3
B. Design	3
C. Spill Prevention and Response Procedures	4
D. Operation and Maintenance	4
E. Housekeeping Practices	5
F. Implementation Sequence	5
G. Record Keeping	5
H. Employee Training	5
IV. Implementation Schedule	5
A. Structural Measures	5
B. Vegetative Measures	5
V. Inspections and Reporting	5
A. Inspections	5
B. Reporting	6
VI. Revisions	6
Appendix A – Vegetative Seeding Schedule	
Appendix B – MDEQ Memo	
Appendix C – Large Construction General Permit	
Appendix D – Mississippi Storm Water Pollution Prevention Plan Guidance Manual for Construction Activities	
Appendix E – Field Manual for Erosion and Sediment Control on Construction Sites in Mississippi	
DRAWINGS	
1. Project Vicinity Drawing	
2. Erosion Control Plan	

I. INTRODUCTION

The purpose of the Storm Water Pollution Prevention Plan (SWPPP) is to provide a site specific description of the best management practices to prevent contamination of the storm water with potential pollutants from construction activities related to the proposed new subdivision in Lamar County, Mississippi. The storm water pollution prevention plan has been prepared as required by the Mississippi Department of Environmental Quality in compliance with the application regulations for coverage under the construction storm water general NPDES permit.

This storm water pollution prevention plan has been developed by Andrews Engineering, PLLC and it is to be incorporated into the routine construction activities at the site. The potential sources of pollution have been identified at the site and are described in this plan. Several pollution control measures are specified in the attached plan to prevent contamination of storm water runoff from those sources. The plan also outlines implementation, inspection, and maintenance requirements. The erosion and sediment control practices should be monitored, and the plan revised if the quality of storm water runoff is not satisfactory.

II. SITE ASSESSMENT

- A. Description of Work: Craig Flanagan is preparing a new residential development which will involve constructing a new road, detention areas, installation of individual on-site wastewater system, and water utilities, and house pads. This will require cut and fill grading, disturbing approximately 27.04 acres more or less. The activity related to the earthwork consist of grading of existing soils on site for final grade.
- B. Potential Pollution Sources: The most significant potential pollutants are soil particles subject to removal by storm water. Other potential pollutants subject to removal by storm water are domestic trash and spilled fuel and lubricants. Material may also be inadvertently tracked off-site or blown off-site when distributed by hauling equipment.
- C. Non-Storm Water Discharges: Potential non-storm water discharges consist of irrigation water and watering of the haul roads to control dust. Due to the permeability of the soil and the arid conditions when this activity is required, no significant impact is anticipated from these sources.
- D. Non-Storm Water Solid Materials: The on-site generation of solid materials will be minimal, and its proper disposal shall be closely monitored. All solid waste will be taken off-site for proper disposal.

- E. Drainage Patterns: The pre-construction storm water drainage patterns split the property. Storm water drains from the west to east draining to the ditches located on the boundary of the property. Plans call for the drainage patterns to change slightly and drain to swales located on the property line located throughout the site. The proposed swales will connect to the existing ditch. A grading plan will be provided for construction.
- F. Receiving Waters: The storm water runoff from this site drains into an existing ditch on the east side of the site eventually draining into Black Creek.

III. BEST MANAGEMENT PRACTICES

- A. General: In order to prevent contamination of storm water by the potential pollutants previously discussed, uncontaminated storm water shall be diverted away from disturbed areas by the use inlet protection filters and where silt fence will allow. These practices shall be installed in accordance with the details provided and located at periodic intervals. Existing vegetation on undisturbed areas shall be maintained as long as possible. If disturbed areas are compacted by heavy equipment, the soil shall be tilled prior to planting.

See Appendix A for seed, fertilizer, and mulching rates. These rates shall be used for both temporary and permanent vegetation. Soil stabilization-vegetative stabilization measures shall be implemented if earthwork activities are stopped for a period of 14+ days and appropriate temporary or permanent vegetation will be implemented within 7 calendar days at rates mentioned above.

- B. Design: The site has three runoff point, so scheduling for certain areas will not affect erosion control.

A gravel construction entrance shall be installed on the west side of the property, that is located off of WPA Road. The gravel construction entrance is installed to help prevent tracking soils off site. All storm inlets shall be protected from siltation and maintained as needed.

The storm water which leaves the site shall meet the non-numeric limitations of being free from the following:

- oil, scum, debris and other floating materials; eroded soils and other materials that will settle out of the storm water to form objectionable deposits in receiving waters;
- suspended solids, turbidity and color levels inconsistent with the receiving waters; and

- chemicals in concentrations that would cause violations of the State Water Quality Criteria in the receiving waters.

- C. Spill Prevention and Response Procedures: At the present time there are no fuel storage tanks at this site. However, if in the future there should be, a dike should be constructed around the fuel storage tanks in order to contain any accidental spillage. The name and number of a competent hazardous waste disposal contractor shall be posted on site for use in the event of a spill. The site shall be kept free from the accumulation of solid waste and other good housekeeping procedures shall be implemented.
- D. Operation and Maintenance: The best management practices once implemented must be maintained to insure that satisfactory operation continues. The sediment traps and diversions should routinely have excess sediment removed. This may be required following each major storm event. This material should be stockpiled and protected from possible re-entry into the storm water until it can be used. Diversions require frequent inspection to insure that traffic has not worn them down or that funneling waters have not washed them out. Vegetative growth on diversions must be checked frequently and action taken if the growth rate is not satisfactory.

The vegetative practices should be fertilized at one half the initial rates at the beginning of the second growing season. Eroded areas should be shaped, smoothed and replanted at this time. Grassed areas should be clipped once a year. Hay bales shall be replaced once they have begun to deteriorate and sediment shall be removed once it has begun to accumulate.

- E. Housekeeping Practices: The owner or prime contractor shall prevent pollutants from entering storm water from the construction site because of poor housekeeping. The owner or prime contractor shall designate areas for equipment maintenance and repair (this shall be done off site if possible or in the area shown on plan if necessary); concrete chute wash off; provide waste receptacles at convenient locations as shown on plan and provide for the regular collection of waste from a waste management company; all fertilizers, fuels, lubricants, and other potentially toxic materials shall be stored off site; and provide a port-o-let on site for restroom facilities.
- F. Implementation Sequence: The site has two runoff points, but scheduling for certain areas will not affect erosion control. The erosion and sedimentation control measures shall be constructed at the beginning of the project and maintained throughout the duration of the project. Implementation Sequence should be as follows:

- 1) Construction Access: Construct entrance, construction routes, and equipment parking areas.

Install required gravel construction entrance as shown on the plan and stabilize any bare areas with temporary vegetation.

- 2) Sediment Barriers: Silt fences and hay bales and wattles.

Install principal barriers on perimeter of site as shown on plan after construction site is accessed. Install additional barriers as needed during construction.

- 3) Land Clearing and Grading: Site preparation, cutting, filling, grading, barriers, diversions, and surface roughening.

Clear borrow and disposal areas only as needed. Install additional erosion control measures as grading progresses. Mark buffer areas for preservation.

- 4) Surface Stabilization: Temporary and permanent seeding and mulching.

Apply temporary or permanent stabilization measures immediately on all disturbed areas where work is delayed or complete.

- G. Record Keeping: Records shall be retained for three years of all maintenance activities, spills, and inspections, including a description of the quality and quantity of storm water.
- H. Employee Training: A staff meeting and pre-construction meeting shall be held for the purpose of discussing the Storm Water Pollution Prevention Plan's components and goals.

IV. IMPLEMENTATION SCHEDULE

- A. Structural Measures: The non-existing structural measures shall be installed as the weather permits, and the existing measures shall be re-conditioned as well.
- B. Vegetative Measures: Vegetative plantings will be performed in accordance with the included planting schedule. Structural measures shall be grassed during the first open planting season after completion. Construction should be scheduled in order that un-vegetated exposure is minimized.

V. INSPECTIONS AND REPORTING

A. Inspections: Inspections of the best management practices and other storm water pollution prevention plan requirements shall be performed by the contractor or owner as follows:

1. At least once every seven calendar days or a minimum of four per month.
2. Within 24 hours after a half-inch (or more) rainfall event.
3. As often as necessary to insure that appropriate erosion and sediment controls have been properly constructed and maintained.

B. Reporting: The owner and/or contractor must inspect, as described in above section, and maintain controls and keep all reports on file noting damages or deficiencies and corrective measures, using the form provided in the appendix of this plan.

Reports shall not be submitted to the Mississippi Department of Environmental Quality unless specifically requested. As previously stated, all records, reports, and information resulting from activities required by this plan and your permit shall be retained for at least three years from the date of the CNOI, inspection or report.

A rain gauge shall be placed in a central location on the site and used to obtain rainfall amounts. This information will be needed for proper completion of the inspection report.

VI. REVISIONS

The storm water pollution prevention plan will be kept current by the company representative and will be revised as changes in site conditions warrant. The company representative may notify the SWPPP developer for assistance when necessary. Factors that would compel the SWPPP to be modified include:

- Inadequacies revealed by routine inspections;
- Changes in identified sources, non-storm water discharges, or non-storm water solid wastes; or
- MDEQ or local agency notification that the plan does not meet one or more of the minimum requirements.

A plan revision shall be completed within 30 days of the date that it is determined that a revision is warranted. If the modification is in response to a request by the MDEQ, the permittee must submit to the MDEQ certification that the requested changes have been made.

APPENDIX A

**APPENDIX A
VEGETATIVE SEEDING RATES FOR EROSION CONTROL**

<u>SPECIES</u>	<u>RATE/ACRE</u>	<u>DATE</u>
Pensacola Bahia	30#	Mar. 1 - June 30
Hulled Common Bermuda	8#	Mar. 1 - May 30
* Browntop Millet	35#	June 1 - Aug 15
Pensacola Bahia	30#	Sept 1 - Nov 15
Unhulled Common Bermuda	10#	Sept 1 - Oct 30
PLUS		
Wheat	90#	Sept 1 - Nov 30
Ryegrass	60#	Sept 1 - Nov 30
* Cereal Rye	90#	Nov 15 - Dec 15

MULCH

Hay or Wheat Straw 2 tons After Seeding

FERTILIZER

13-13-13 600# Before Seeding
Lime 2 tons Before Seeding

A current soil analysis recommendation may be substituted.

SEED BED PREPARATION

Slope all banks to a minimum of 3:1. Flatter if possible.

After shaping and smoothing, pulverize soil to depth of 6 inches and harrow. Lime and fertilizer can be incorporated during seed bed preparation.

* - Temporary Cover to be followed with a perennial

APPENDIX B



STATE OF MISSISSIPPI

PHIL BRYANT
GOVERNOR

MISSISSIPPI DEPARTMENT OF ENVIRONMENTAL QUALITY

TRUDY D. FISHER, EXECUTIVE DIRECTOR

To: Construction Project Owner or Contractor (Operator)

From: Mississippi Department of Environmental Quality (MDEQ) Environmental Permits Division, General Permits Branch

Subject: Storm Water Requirements for Small Construction Activities that Disturb One (1) Acre to Less Than Five (5) Acres

There are two different storm water general permits that cover construction activities in Mississippi. Construction activities that disturb one acre to less than five acres require coverage under the Small Construction General Permit issued January 3, 2008. Construction activities that disturb five acres and greater require coverage under the Large Construction General Permit issued January 11, 2011. The "larger common plan of development or sale" requirement, where the total acreage is based on cumulative planned disturbance, is applicable to both general permits.

The requirements of the Small Construction General Permit are similar to the Large Construction General Permit. However, there is one fundamental difference. **There will be no submittals to MDEQ unless specifically requested.** The owner or operator must follow the requirements of the Small Construction General Permit. The entire permit should be carefully read and understood, but the basic requirements are:

- Complete the Small Construction Notice of Intent (SCNOI) application form found in the Forms Section at the end of the General Permit and keep the form on the project site or have it locally available.
- Develop and implement a Storm Water Pollution Prevention Plan (SWPPP) as described and required by ACT 5 of the General Permit. The SWPPP is required to stop or reduce the amount of pollutants in storm water discharges. In addition, a guidance manual that can help in developing a SWPPP can be found on our web site. This plan must be made available to the contractor.
- Inspect the site weekly for a minimum of four inspections per month to make sure the sediment and erosion controls are still working. This information must be recorded on the Inspection Form found on page 28 of the General Permit. Again, these forms are to be kept on site or they must be locally available.

Once the requirements of the Small Construction General Permit are followed the owner or operator is authorized to discharge storm water associated with construction activity. If you have any questions or need help in completing any of the forms or developing the SWPPP please contact the EPD Construction Branch at 601/961-5171. This information can also be found on our web site at www.deq.state.ms.us/MDEQ.nsf/page/epd_epdgeneral.

OFFICE OF POLLUTION CONTROL

POST OFFICE BOX 2261 • JACKSON, MISSISSIPPI 39225-2261 • TEL: (601) 961-5171 • FAX: (601) 354-6612 • www.deq.state.ms.us

AN EQUAL OPPORTUNITY EMPLOYER

APPENDIX C

AI: 87377

MSR109388



Rec'd via email:
09/19/2024

MISSISSIPPI DEPARTMENT OF
ENVIRONMENTAL QUALITY

LARGE CONSTRUCTION NOTICE OF INTENT (LCNOI) FOR COVERAGE UNDER THE LARGE CONSTRUCTION STORM WATER GENERAL NPDES PERMIT

INSTRUCTIONS

The Large Construction Notice of Intent (LCNOI) is for coverage under the Large Construction General Permit for land disturbing activities of five (5) acres or greater; or for land disturbing activities, which are part of a larger common plan of development or sale that are initially less than five (5) acres but will ultimately disturb five (5) or more acres. Applicant must be the owner or operator. For construction activities, the operator is typically the prime contractor. The owner(s) of the property and the prime contractor associated with regulated construction activity on the property have joint and severable responsibility for compliance with the Large Construction Storm Water General Permit MSR10.

If the company seeking coverage is a corporation, a limited liability company, a partnership, or a business trust, attach proof of its registration with the Mississippi Secretary of State and/or its Certificate of Good Standing. This registration or Certificate of Good Standing must be dated within twelve (12) months of the date of the submittal of this coverage form. Coverage will be issued in the company name as it is registered with the Mississippi Secretary of State.

Completed LCNOIs should be filed at least thirty (30) days prior to the commencement of construction. Discharge of storm water from large construction activities without written notification of coverage is a violation of state law.

Submittals with this LCNOI must include:

- A site-specific Storm Water Pollution Prevention Plan (SWPPP) developed in accordance with ACT5 of the General Permit
- A detailed site-specific scaled drawing showing the property layout and the features outlined in ACT5 of the General Permit
- A United States Geological Survey (USGS) quadrangle map or photocopy, extending at least one-half mile beyond the facility property boundaries with the site location and outfalls outlined or highlighted. The name of the quadrangle map must be shown on all copies. Quadrangle maps can be obtained from the MDEQ, Office of Geology at 601-961-5523.

Additional submittals may include the following, if applicable:

- Appropriate Section 404 documentation from U.S. Army Corps of Engineers
- Appropriate documentation concerning future disposal of sanitary sewage and sewage collection system construction
- Appropriate documentation from the MDEQ Office of Land & Water concerning dam construction and low flow requirements
- Approval from County Utility Authority in Hancock, Harrison, Jackson, Pearl River and Stone Counties
- Antidegradation report for disturbance within Waters of the State

ALL QUESTIONS MUST BE ANSWERED (Answer "NA" if the question is not applicable)

O.C

1

MSR10 9388

(NUMBER TO BE ASSIGNED BY STATE)

APPLICANT IS THE: OWNER PRIME CONTRACTOR

OWNER CONTACT INFORMATION

OWNER CONTACT PERSON: CRAIG FLANAGAN

OWNER COMPANY LEGAL NAME: FLANAGAN CONSTRUCTION, LLC

OWNER STREET OR P.O. BOX: P.O. BOX 15033

OWNER CITY: HATTIESBURG STATE: MS ZIP: 39404

OWNER PHONE #: (601) 264-3682 OWNER EMAIL: craig@flanaganconstruction.com

PREPARER CONTACT INFORMATION

IF NOI WAS PREPARED BY SOMEONE OTHER THAN THE APPLICANT

CONTACT PERSON: _____

COMPANY LEGAL NAME: _____

STREET OR P.O. BOX: _____

CITY: _____ STATE: _____ ZIP: _____

PHONE # () EMAIL: _____

PRIME CONTRACTOR CONTACT INFORMATION

PRIME CONTRACTOR CONTACT PERSON: _____

PRIME CONTRACTOR COMPANY LEGAL NAME: _____

PRIME CONTRACTOR STREET OR P.O. BOX: _____

PRIME CONTRACTOR CITY: _____ STATE: _____ ZIP: _____

PRIME CONTRACTOR PHONE #: () PRIME CONTRACTOR EMAIL: _____

FACILITY SITE INFORMATION

FACILITY SITE NAME: TREVOR TRAILS SUBDIVISION PROJECT

FACILITY SITE ADDRESS (If the physical address is not available, please indicate the nearest named road. For linear projects indicate the beginning of the project and identify all counties the project traverses.)

STREET: WPA ROAD

CITY: PURVIS STATE: MS COUNTY: LAMAR ZIP: 39475

FACILITY SITE TRIBAL LAND ID (N/A If not applicable): _____

LATITUDE: N31 degrees 15 minutes 35 33 seconds LONGITUDE: W89 degrees 29 minutes 29 seconds

LAT & LONG DATA SOURCE (GPS (Please GPS Project Entrance/Start Point) or Map Interpolation): MAP INTERPOLATION

TOTAL ACREAGE THAT WILL BE DISTURBED 1: 27.04 AC

IS THIS PART OF A LARGER COMMON PLAN OF DEVELOPMENT? YES NO

IF YES, NAME OF LARGER COMMON PLAN OF DEVELOPMENT: BLACK CREEK
 AND PERMIT COVERAGE NUMBER: MSR10

ESTIMATED CONSTRUCTION PROJECT START DATE: 2024-10-01
 YYYY-MM-DD

ESTIMATED CONSTRUCTION PROJECT END DATE: 2025-07-31
 YYYY-MM-DD

DESCRIPTION OF CONSTRUCTION ACTIVITY: Minor cut/fill grading for roads, lots, detention ponds, and installation of water and sewer

PROPOSED DESCRIPTION OF PROPERTY USE AFTER CONSTRUCTION HAS BEEN COMPLETED:
RESIDENTIAL SUBDIVISION

SIC Code: 1 5 2 1 NAICS Code 2 3 6 1 1 5

NEAREST NAMED RECEIVING STREAM: BLACK CREEK

IS RECEIVING STREAM ON MISSISSIPPI'S 303(d) LIST OF IMPAIRED WATER BODIES? (The 303(d) list of impaired waters and TMDL stream segments may be found on MDEQ's web site: http://www.deq.state.ms.us/MDEQ.nsf/page/TWB_Total_Maximum_Daily_Load_Section) YES NO

HAS A TMDL BEEN ESTABLISHED FOR THE RECEIVING STREAM SEGMENT? YES NO

FOR WHICH POLLUTANT:

ARE THERE RECREATIONAL STREAMS, PRIVATE/PUBLIC PONDS OR LAKES WITHIN 1/2 MILE DOWNSTREAM OF PROJECT BOUNDRY THAT MAY BE IMPACTED BY THE CONSTRUCTION ACTIVITY? YES NO

EXISTING DATA DESCRIBING THE SOIL (for linear projects please describe in SWPPP):

WILL FLOCCULANTS BE USED TO TREAT TURBIDITY IN STORM WATER? YES NO

IF YES, INDICATE THE TYPE OF FLOCCULANT, ANIONIC POLYACRYLIMIDE (PAM)
 OTHER _____

IF YES, DOES THE SWPPP DESCRIBE THE METHOD OF INTRODUCTION, THE LOCATION OF INTRODUCTION AND THE LOCATION OF WHERE FLOCCULATED MATERIAL WILL SETTLE?

IS A SDS SHEET INCLUDED FOR THE FLOCCULATE? YES NO

WILL THERE BE A 50 FT BUFFER BETWEEN THE PROJECT DISTURBANCE AND THE WATERS OF THE STATE? YES NO

IF NOT, PROVIDE EQUIVALENT CONTROL MEASURES IN THE SWPPP.

¹ Acreage for subdivision development includes areas disturbed by construction of roads, utilities and drainage. Additionally, a housesite of at least 10,000 ft² per lot (entire lot, if smaller) shall be included in calculating acreage disturbed.

DOCUMENTATION OF COMPLIANCE WITH OTHER REGULATIONS/REQUIREMENTS
 COVERAGE UNDER THIS PERMIT WILL NOT BE GRANTED UNTIL ALL OTHER REQUIRED
 MDEQ PERMITS AND APPROVALS ARE SATISFACTORILY ADDRESSED

IS LCNOI FOR A FACILITY THAT WILL REQUIRE OTHER PERMITS? YES NO

IF YES, CHECK ALL THAT APPLY: AIR HAZARDOUS WASTE PRETREATMENT
 WATER STATE OPERATING INDIVIDUAL NPDES OTHER: _____

IS THE PROJECT REROUTING, FILLING OR CROSSING A WATER CONVEYANCE OF ANY KIND? (If yes, contact the U.S. Army Corps of Engineers' Regulatory Branch for permitting requirements.) YES NO

IF THE PROJECT REQUIRES A CORPS OF ENGINEER SECTION 404 PERMIT, PROVIDE APPROPRIATE DOCUMENTATION THAT:

- The project has been approved by individual permit, or
- The work will be covered by a nationwide permit and NO NOTIFICATION to the Corps is required, or
- The work will be covered by a nationwide or general permit and NOTIFICATION to the Corps is required

IS THE PROJECT REROUTING, FILLING OR CROSSING A STATE WATER CONVEYANCE OF ANY KIND? (If yes, please provide an antidegradation report.) YES NO

IS A LAKE REQUIRING THE CONSTRUCTION OF A DAM BEING PROPOSED? (If yes, provide appropriate approval documentation from MDEQ Office of Land and Water, Dam Safety.) YES NO

IF THE PROJECT IS A SUBDIVISION OR A COMMERCIAL DEVELOPMENT, HOW WILL SANITARY SEWAGE BE DISPOSED? Check one of the following and attach the pertinent documents.

- Existing Municipal or Commercial System. Please attach plans and specifications for the collection system and the associated "Information Regarding Proposed Wastewater Projects" form or approval from County Utility Authority in Hancock, Harrison, Jackson, Pearl River and Stone Counties. If the plans and specifications can not be provided at the time of LCNOI submittal, MDEQ will accept written acknowledgement from official(s) responsible for wastewater collection and treatment that the flows generated from the proposed project can and will be transported and treated properly. The letter must include the estimated flow.
- Collection and Treatment System will be Constructed. Please attach a copy of the cover of the NPDES discharge permit from MDEQ or indicate the date the application was submitted to MDEQ (Date: _____.)
- Individual Onsite Wastewater Disposal Systems for Subdivisions Less than 35 Lots. Please attach a copy of the Letter of General Acceptance from the Mississippi State Department of Health or certification from a registered professional engineer that the platted lots should support individual onsite wastewater disposal systems.
- Individual Onsite Wastewater Disposal Systems for Subdivisions Greater than 35 Lots. A determination of the feasibility of installing a central sewage collection and treatment system must be made by MDEQ. A copy of the response from MDEQ concerning the feasibility study must be attached. If a central collection and wastewater system is not feasible, then please attach a copy of the Letter of General Acceptance from the State Department of Health or certification from a registered professional engineer that the platted lots should support individual onsite wastewater disposal systems.

INDICATE ANY LOCAL STORM WATER ORDINANCE (I.E. MS4) WITH WHICH THE PROJECT MUST COMPLY:

I certify under penalty of law that this document and all attachments were prepared under my direction or supervision in accordance with a system designed to assure that qualified personnel properly gathered and evaluated the information submitted. Based on my inquiry of the person or persons who manage the system, or those persons directly responsible for gathering the information, the information submitted is, to the best of my knowledge and belief, true, accurate and complete. I am aware that there are significant penalties for submitting false information, including the possibility of fine and imprisonment for knowing violations.

C. Flanagan
Signature of Applicant (owner or prime contractor)

9/10/24
Date Signed

Cecil Flanagan
Printed Name

manager member
Title

This application shall be signed as follows:

- For a corporation, by a responsible corporate officer.
- For a partnership, by a general partner.
- For a sole proprietorship, by the proprietor.

For a municipal, state or other public facility, by principal executive officer, mayor, or ranking elected official

Please submit the LCNOI form to:

Chief, Environmental Permits Division
MS Department of Environmental Quality, Office of Pollution Control
P.O. Box 2261
Jackson, Mississippi 39225

Electronically:

<https://www.mdeq.ms.gov/construction-stormwater/>

Revised 3/23/22



CONSTRUCTION MINIMUM MEASURE ASSISTANCE PETITION SMALL MUNICIPAL SEPARATE STORM SEWER SYSTEM (MS4) GENERAL PERMIT

GENERAL PERMIT: MSRMS4 __ __ __. This coverage number must be completed for the referenced MS4 or this form will be considered incomplete and will be returned. The coverage number can be found at the bottom left corner of your previous Certificate of Coverage.

INSTRUCTIONS

The form must be submitted to petition MDEQ to assume responsibility for the regulation of storm water runoff from construction activities five (5) acres and greater.

The MS4 General Permit requires regulated entities (MS4s) to develop and implement a Storm Water Management Program (SWMP) to reduce the discharge of pollutants from their storm water conveyance systems. The SWMP must include six (6) minimum control measures, including Construction Site Storm Water Runoff Control from construction activities that result in a land disturbance of greater than or equal to one (1) acre or less if part of a larger common plan of development or sale. ACT6, SHARING MINIMUM MEASURE RESPONSIBILITY of the General Permit allows the regulated entity to petition MDEQ to assume responsibility for the regulation of storm water runoff from large construction activities five (5) acres and greater.

Activities that disturb less than five (5) acres remain the MS4's responsibility, including activities that are part of a larger common plan of development or sale. For example, the MS4 is responsible for regulating storm water runoff from individual lot construction even though the large residential subdivision had been covered under MDEQ's Large Construction Storm Water General Permit.

If MDEQ agrees to assume this responsibility, the regulated entity is not required to include MDEQ's portion of the minimum control measure in the SWMP, nor required to address large construction in the annual report. If MDEQ does not agree to assume this responsibility, the regulated entity will be notified in writing.

MS4 INFORMATION

MS4 NAME: _____

MS4 MAILING ADDRESS: _____

MS4 CITY: _____ STATE: _____ ZIP: _____

MS4 COUNTY: _____

MS4 IS A: CITY/TOWN COUNTY OTHER: _____

LOCAL CONTACT NAME (responsible for construction storm water program implementation): _____

CONTACT'S TITLE: _____ OFFICE PHONE: (____) _____

CELL PHONE: (____) _____ FAX NUMBER: (____) _____

E-MAIL ADDRESS (local contact): _____

E-MAIL ADDRESS (legally responsible person): _____

In accordance with ACT6, SHARING MINIMUM MEASURE RESPONSIBILITY of the General Permit, the regulated entity (MS4) described above, requests the Mississippi Department of Environmental Quality (MDEQ) to assume responsibility for regulating storm water runoff from large construction activities, five (5) acres and greater. I understand that the above MS4 is still required to develop and implement a Storm Water Management Plan to reduce pollutants from construction activities less than five (5) acres in accordance with ACT5 of the general permit.

Craig Flanagan _____
Authorized Signature Date 9/10/24

Craig Flanagan _____
Printed Name Title Manager Member

- ¹This application shall be signed according to the General Permit, ACT10, SIGNATORY REQUIREMENTS, as follows:
- For a corporation, by a responsible corporate officer.
 - For a partnership, by a general partner.
 - For a sole proprietorship, by the proprietor.
 - For a municipal, state or other public facility, by either a principal executive officer, the mayor, or ranking elected official.

Please submit this form to: **Chief, Environmental Permits Division
MDEQ, Office of Pollution Control
P.O. Box 2261
Jackson, Mississippi 39225**

PRIME CONTRACTOR CERTIFICATION

LARGE CONSTRUCTION GENERAL PERMIT

Coverage No. MSR10 _____ County Lamar
(Fill in your Certificate of Coverage Number and County)



By completing and submitting this form to MDEQ, the prime contractor is certifying that (1) they have operational control over the erosion and sediment control specifications (including the ability to make modifications to such specifications) or (2) they have day-to-day operational control of those activities at the site necessary to ensure compliance with the SWPPP and applicable permit conditions.

The owner(s) of the property and the prime contractor associated with regulated construction activity on the property have joint and severable responsibility for compliance with the permit. Notwithstanding any permit condition to the contrary, the coverage recipient and any person who causes pollution of waters of the state or places waste in a location where they are likely to cause pollution of any waters of the state shall remain responsible under applicable federal and state laws and regulations and applicable permits.

PRIME CONTRACTOR INFORMATION

PRIME CONTRACTOR CONTACT PERSON: Craig Flanagan PHONE NUMBER: () 601-264-3682
PRIME CONTRACTOR COMPANY: Flanagan Construction, LLC
PRIME CONTRACTOR STREET (P.O. BOX): P.O. Box 15033
PRIME CONTRACTOR CITY: Hattiesburg STATE: MS ZIP: 39404
E-MAIL ADDRESS: craig@flanaganconstruction.com

OWNER INFORMATION

OWNER CONTACT PERSON: Craig Flanagan PHONE NUMBER: (601) 264-3682
OWNER COMPANY NAME: Flanagan Construction, LLC

PROJECT INFORMATION

PROJECT NAME: Trevor Trails Subdivision Project
DESCRIPTION OF CONSTRUCTION ACTIVITY: cut/fill and grading for road, lots, house pads, detention areas, erosion control, and installation of water and sewer
PHYSICAL SITE ADDRESS (If the physical address is not available indicate the nearest named road. For linear projects, indicate the beginning of the project and identify all counties the project traverses.)
STREET: WPA Road
CITY: Purvis COUNTY: Lamar

I certify that I am the prime contractor for this project and will comply with all the requirements in the above referenced general NPDES permit. I further certify under penalty of law that this document and all attachments were prepared under my direction or supervision in accordance with a system designed to assure that qualified personnel properly gathered and evaluated the information submitted. Based on my inquiry of the person or persons who manage the system, or those persons directly responsible for gathering the information, the information submitted is, to the best of my knowledge and belief, true, accurate and complete. I am aware that there are significant penalties for submitting false information, including the possibility of fine and imprisonment for knowing violations.

Craig Flanagan
Prime Contractor Signature

9/10/24
Date Signed

Craig Flanagan
Printed Name

Manager Member
Title

- This application shall be signed as follows:
- For a corporation, by a responsible corporate officer.
 - For a partnership, by a general partner.
 - For a sole proprietorship, by the proprietor.
 - For a municipal, state or other public facility, by principal executive officer, mayor, or ranking elected official.

This Prime Contractors Certification form shall be submitted to:
Chief, Environmental Permits Division
MS Department of Environmental Quality, Office of Pollution Control
P.O. Box 2261
Jackson, Mississippi 39225

Keep a Copy Available at the Permitted Facility or Locally Available
 Submit the Inspection Reports Only if Requested by the Mississippi Department of Environmental Quality (MDEQ)

**LARGE CONSTRUCTION GENERAL PERMIT
 SITE INSPECTION AND CERTIFICATION FORM
 COVERAGE NUMBER (MSR10 _____)**



INSTRUCTIONS

Results of construction storm water inspections required by ACT6 of this permit shall be recorded on this report form and kept with the Storm Water Pollution Prevention Plan (SWPPP) in accordance with the inspection documentation provisions of ACT9 of the this permit. Inspections shall be performed at least weekly for a minimum of four inspections per month. The coverage number must be listed at the top of all Inspection and Certification Forms.

COVERAGE RECIPIENT INFORMATION

OWNER/PRIME CONTRATOR NAME: Craig Flanagan - Flanagan Construction, LLC
 PROJECT NAME: Trevor Trails Subdivision Project
 PROJECT STREET ADDRESS: WPA Road
 PROJECT CITY: Purvis PROJECT COUNTY: Lamar
 OWNER/PRIME CONTRACTOR MAILING ADDRESS: P.O. Box 15033
 MAILING CITY: Hattiesburg STATE: MS ZIP: 39404
 CONTACT PERSON: Craig Flanagan CONTACT PHONE NUMBER: (601) 264-3682
 EMAIL ADDRESS: craig@flanaganconstruction.com

INSPECTION DOCUMENTATION

DATE (mo/day/yr)	TIME (hr:min AM/PM)	ANY DEFICIENCIES? (CHECK IF YES)	INSPECTOR(S)
		<input type="checkbox"/>	
		<input type="checkbox"/>	
		<input type="checkbox"/>	
		<input type="checkbox"/>	
		<input type="checkbox"/>	
		<input type="checkbox"/>	

Deficiencies Noted During any Inspection (give date(s); attach additional sheets if necessary): _____

Corrective Action Taken or Planned (give date(s); attach additional sheets if necessary): _____

Based upon this inspection, which I or personnel under my direct supervision conducted, I certify that all erosion and sediment controls have been implemented and maintained, except for those deficiencies noted above, in accordance with the Storm Water Pollution Prevention Plan (SWPPP) and sound engineering practices as required by the above referenced permit. I further certify that the LCNOI and SWPPP information is up to date.

I certify under penalty of law that this document and all attachments were prepared under my direction or supervision in accordance with a system designed to assure that qualified personnel properly gather and evaluate the information submitted. Based on my inquiry of the person or persons responsible for gathering the information, the information submitted is, to the best of my knowledge and belief, true, accurate and complete. I am aware that there are significant penalties for submitting false information, including the possibility of fines and imprisonment for knowing violations.

Craig Flanagan
 Authorized Signature
Craig Flanagan
 Printed Name

9/10/24
 Date
manager
 Title



Employee Training Log

Instructions: Newly hired employees responsible for implementing and/or complying with the requirements of the permit shall receive initial training prior to performing such responsibilities. Employees shall receive refresher training at a minimum of every twelve (12) months, thereafter. Proper documentation of employee training must be maintained. Include copies of the training agenda and certificates of training when applicable. All training records shall be maintained for at least three years from the date of training. [Large Construction General Permit ACT9 R-1]

Facility Name:			Physical Address:			
Coverage Number:			Training Date:			
Training Topic:						
Training Description:						
Employee Name (printed)	Employee Signature	Worker ID Number	Initial/Refresher			

“I certify under penalty of law that this report is true, accurate, and complete, to the best of my knowledge and belief.”

Trainer Name (printed)	Trainer Signature	Date
------------------------	-------------------	------

APPENDIX D

MISSISSIPPI STORM WATER POLLUTION PREVENTION PLAN (SWPPP) GUIDANCE MANUAL FOR CONSTRUCTION ACTIVITIES

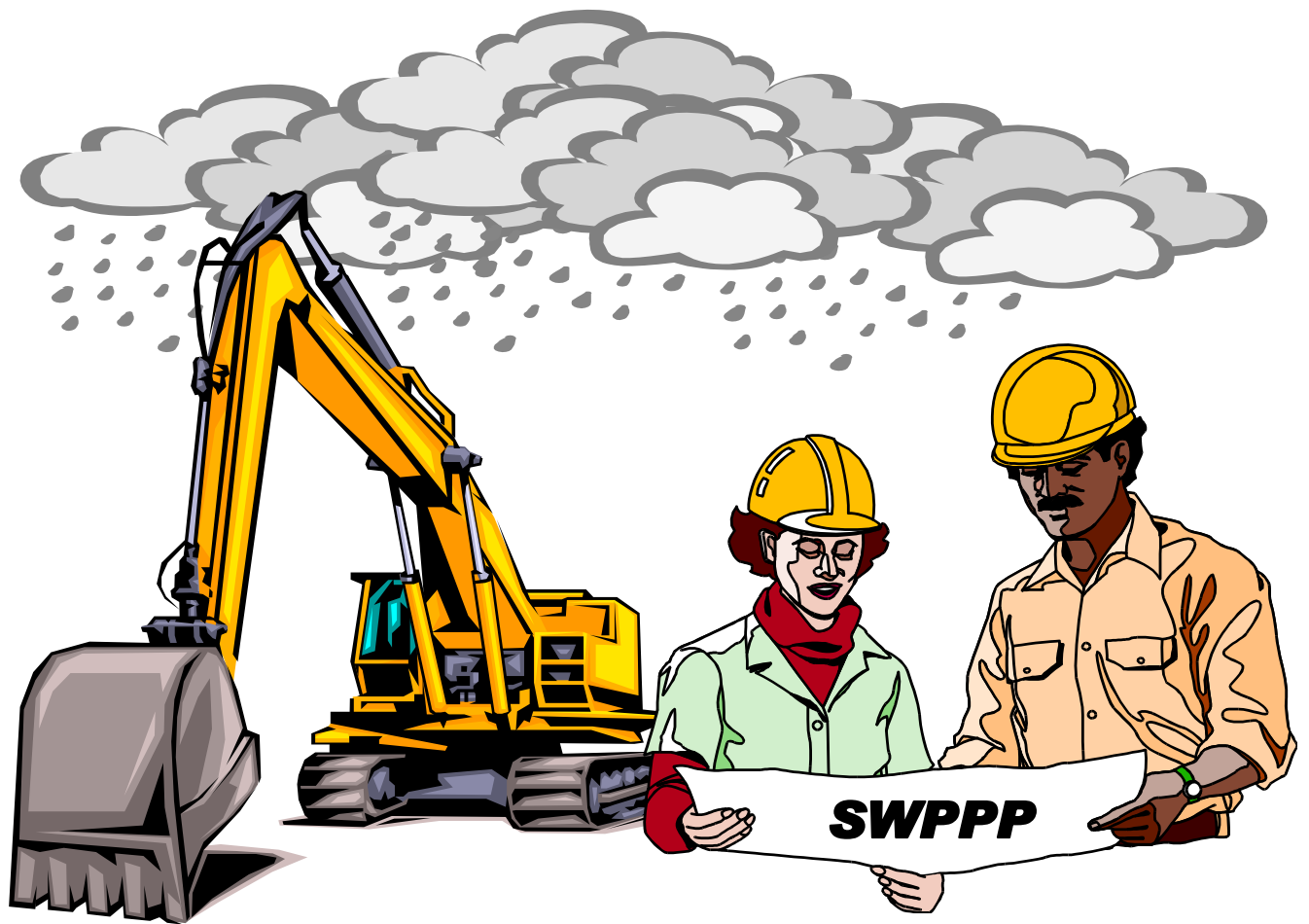

*General Permits Branch
Office of Pollution Control
Mississippi Department of Environmental Quality
P. O. Box 2261
Jackson, Mississippi 39225
December 2016*

TABLE OF CONTENTS

	<u>Page</u>
INTRODUCTION	3
PART I COLLECT SITE INFORMATION.....	4
PART II CHOOSE CONTROLS.....	5
PART III PREPARE SWPPP	16
PART IV APPLY FOR PERMIT COVERAGE.....	18
PART V IMPLEMENT CONTROLS.....	18
PART VI STABILIZE SITE & TERMINATE COVERAGE	18
SAMPLE STORM WATER POLLUTION PREVENTION PLAN (SWPPP).....	19
SAMPLE SITE MAP.....	20
SAMPLE STORM WATER POLLUTION PREVENTION PLAN FOR INDIVIDUAL LOTS IN A RESIDENTIAL SUBDIVISION	21
INDIVIDUAL RESIDENTIAL LOT SWPPP SAMPLES.....	23
WORKSHEET 1 – CHECKLIST SHEET FOR EROSION & SEDIMENT CONTROLS.....	24
FREQUENTLY ASKED QUESTIONS.....	26

CHARTS

CHART 1 - SEEDING CHART FOR THE STATE OF MISSISSIPPI.....	7
---	---

This manual is primarily derived from Chapters 2, 3 and 4 of EPA's "Storm Water Management for Construction Activities, Developing Pollution Prevention Plans and Best Management Practices," September 1992, and Chapters 3, 4 and 5 of The Mississippi Department of Environmental Quality, Mississippi Soil & Water Conservation Commission and USDA Soil Conservation Service's Planning & Design Manual for the Control of Erosion, Sediment & Stormwater," April 1994. It was originally edited by Mississippi Office of Pollution Control staff Kenneth LaFleur and Louis Lavallee, and most recently by Jim Morris and Dmitriy Asanov, who thank those who reviewed and commented on the draft. See our web site for more Storm Water information at www.deq.state.ms.us.

INTRODUCTION

This document is a guide for developing a **Storm Water Pollution Prevention Plan (SWPPP)** for the Mississippi Department of Environmental Quality (MDEQ) as required in the State of Mississippi's Large and Small Construction Storm Water General NPDES Permits. The Large Construction General Permit (MSR10) authorizes storm water discharges from land disturbing activities of five (5) acres or greater; or for land disturbing activities that are part of a larger common plan of development or sale that will disturb five (5) or more acres. The Small Construction General Permit (MSR15) authorizes storm water discharges from land disturbing activities of one (1) acre to less than five (5) acres; or for land disturbing activities less than one (1) acre that are part of a larger common plan of development or sale that will disturb one (1) to less than five (5) acres. These permits must be consulted for complete requirements. For a more thorough description of erosion and sediment controls, see the most recent edition of the "**Erosion Control, Sediment Control and Stormwater Management on Construction Sites and Urban Areas (Three Volumes)**," which may be accessed electronically at: http://deq.state.ms.us/MDEQ.nsf/page/NPS_PlanningandDesignManual2ndEd_Vol1?OpenDocument

This document is organized according to the six parts of SWPPP planning and implementation:

- **PART I** **Collect Site Information**
- **PART II** **Choose Controls**
- **PART III** **Prepare SWPPP**
- **PART IV** **Apply for Permit Coverage**
- **PART V** **Implement Controls**
- **PART VI** **Stabilize Site & Terminate Coverage**

When developing a SWPPP, always consider the following items:

- **Divert** upslope water around disturbed areas.
- **Control** storm water volume and velocity within the site
- **Disturb** the smallest area possible. Remember, by disturbing large areas that have high erosion potential, the cost of erosion and sediment controls will greatly increase.
- **Phasing-Schedule** or sequence construction activities so as to concentrate work in certain areas so as to minimize the amount of soil that is exposed at one time.
- **Preserve** existing vegetation where possible, especially trees.
- **Provide and maintain** natural buffers around surface waters.
- **Avoid** disturbing sensitive areas such as:
 - Steep and/or unstable slopes
 - Land upslope of surface waters
 - Areas with erodible soils
 - Existing drainage channels
- **Limit** exposure of disturbed areas to the shortest time possible by revegetating disturbed areas as soon as possible.
- **Minimize** the amount of cut and fill, and soil compaction.
- **Transport runoff** down steep slopes through lined channels or piping.
- **Remove sediment from storm water before it leaves the site** by allowing runoff to pond in controlled areas to drop out sediment. Filter runoff by using natural vegetation, brush barriers, silt fences or hay bales.
- **Minimize** off-site vehicle tracking of sediments.

PART I

COLLECT SITE INFORMATION

- **Existing soils information** - *Are the soils susceptible to erosion?* For information see the Natural Resources Conservation Service (NRCS) soil surveys or call the State Conservationist through the State Office in Jackson at **(601) 965-5196** or **5205**. The NRCS is the former Soil Conservation Service.
- **Receiving water(s)** - Identify any lakes, streams, ponds or wetlands that may receive site runoff. If sensitive water bodies are downstream (for example: wild and scenic rivers, recreational streams, natural aquatic sites, private ponds and lakes or receiving streams listed on the Impaired Water Bodies 303(d) list or segments for which a Total Daily Maximum Load (TMDL) has been approved) extra erosion controls will be needed. A discussion of the Impaired Water Bodies follows. For assistance in locating adjacent or downstream waterbodies, see the appropriate USGS Quad map(s), a photocopy of which must be submitted along with the SWPPP. To obtain USGS Quad maps contact the Mississippi Office of Geology at **(601) 961-5523**.
- **List of Impaired Water bodies** - Mississippi's waters are used for public water supply, shell fish harvesting, recreation, and fishing & aquatic life support. The MDEQ assesses State waters every two years to determine if their uses are supported. A water body is said to be impaired when its use is partially or non-supportive. Construction sites, whose receiving streams that are on the list of impaired waters due to siltation, suspended solids, sediment, turbidity or habitat alterations, require additional erosion and sediment controls. These additional controls are intended to ensure that sediment will not further impact those impaired waters. Impaired waters are issued TMDLs, which represent the amounts of pollutants that can enter a water body so that the water body will meet and continue to meet state water quality standards. A list of water bodies with established TMDLs and an updated list of Section 303(d) streams can be accessed at http://www.deq.state.ms.us/MDEQ.nsf/page/TWB_Total_Maximum_Daily_Load_Section?OpenDocument. For more information concerning 303(d) listed streams, please contact the Water Quality Assessment Branch of the MDEQ at **(601) 961-5171**.
- **U. S. Army Corps of Engineers** - If your project is rerouting, filling or crossing a water conveyance of any kind, you should contact the U. S. Army Corps of Engineers, Regulatory Branch in your area for possible permitting requirements. For information call the Vicksburg Corps District at **(601) 631-7071** or the Mobile Corps District at **251-690-2658**.
- **Calculating total acreage disturbed** – Total acreage disturbed includes the total area disturbed over the course of the project. For subdivisions, this includes roads, utilities, drainage and home sites. A minimum of 10,000 ft² per home site or the entire lot, if smaller, shall be included. Acreage may be determined by dividing square footage by 43,560, as demonstrated in the following example:

Convert 54,450 ft² to acres (*square footage is obtained by multiplying the length of the disturbed area by the width of the disturbed area*)

Divide 54,450 ft² by 43,560 ft² per acre:

54,450 ft² ÷ 43,560 ft²/acre = 1.25 acres
(Small construction coverage would be required for 1.25 acres of disturbance)
- **Determine drainage areas** - For each point where concentrated flow will leave the site, the drainage area should be determined. Drainage areas are portions of the site where runoff will flow in one particular direction or to a particular discharge point. This will help you select and design the appropriate sediment controls. The USGS Quad map(s) may be useful in determining drainage areas.

PART II

CHOOSE CONTROLS

Select vegetative and structural controls; housekeeping practices; post-construction/storm water management measures & controls to be used prior to, during and after land disturbing activities. The SWPPP must include a description of the measures and controls that will be used throughout the construction project. Incorporate any municipal, county or other required controls into your SWPPP.

1. **Vegetative controls** are an inexpensive and effective way to protect soil from raindrop impact, a major erosion force. It also decreases erosion due to flowing water by reducing its velocity. Roots from vegetation hold the soil in place and increase infiltration. **Topsoil should be added where existing soils are not suitable for adequate vegetative growth.** Please indicate if soil amendments are to be used.

- **Vegetative buffer zones** are undisturbed or planted vegetated areas that surround a development, land disturbance activity or that border an intermittent stream or permanent water body. Buffer zones aid in sediment filtration and removal. If possible, construction site runoff should be spread out over entire buffer zone length. A minimum 15-foot wide buffer zone is recommended. A minimum 150-foot buffer zone is recommended adjacent to perennial streams and water bodies.
- **Sod stabilization**, the most effective vegetative practice available, involves establishing long-term stands of grass with sod on exposed surfaces. Properly installed and maintained sodding can be more than 99 percent effective in reducing erosion.

- **Protection of trees** involves preserving and protecting selected trees that exist on the site prior to development. Mature trees provide extensive canopy and root systems that hold soil in place. It is important to provide tree protection to the tree drip line rather than only around the perimeter of the trunk. Shade trees also keep soils from drying rapidly and becoming susceptible to erosion, in addition to increasing property value.

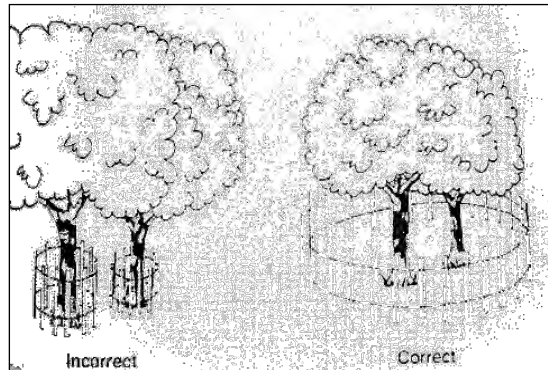

- **Tillage, with lime and fertilizer**, may be important before seeding. The Cooperative Extension Service local agent can analyze soil for lime and fertilizer needs.
- **Temporary seeding** is the planting of fast-growing annual grasses to hold the soil in areas that will not be disturbed again for 14 or more days. The appropriate temporary vegetative practices must be implemented immediately. For long term protection (greater than one year), permanent seeding should be initiated. The seeding chart on page 7 lists annuals that may be used. Mulching helps ensure seed growth and is essential when slopes are steep, weather is hot or dry and soil conditions are poor.
- **Permanent seeding** is the use of perennial grass (with trees & shrubs) to stabilize the soil. The appropriate permanent vegetative practices must be implemented immediately. The seeding chart on page 7 lists perennials that may be used. Vegetation is often not fully established until one (1) year from planting. Inspect, repair and re-seed as needed, evaluating choice of seed and quantities of lime and fertilizer. Use temporary seeding if the time of year is not appropriate for permanent seeding. **Sodding may be needed in highly erodible areas.**

- **Mulching** is the placement of hay, grass, wood chips, straw, or synthetic material on the soil. Mulch holds moisture, dampens temperature extremes and retards erosion on steep slopes during seed establishment. Soils that cannot be seeded due to the season should be mulched to provide temporary protection.
- **Erosion & sediment control blankets** are machine-produced mats of straw or other fibers held together with netting that provide temporary or permanent stabilization in critical areas, such as slopes or channels, so that vegetation may be established. On slopes shallower than 2:1, blankets should be laid perpendicular to the direction of flow. However, on steep slopes (> 3:1) and in areas of concentrated flows (ditches, swales, storm water conveyance channels), blankets should be laid in parallel to the direction of flow. Blankets should be anchored in a six (6) inch trench and should overlap by three (3) inches if strips are laid side by side.
- **Surface roughening** involves using heavy equipment to create grooves on bare soil in a perpendicular direction across the slope. Roughening loosens compacted soils in order to reduce runoff velocity and erosion while aiding in seed growth. Roughened slopes should be immediately seeded and mulched.
- Slopes that will be mowed should be grooved with shallow grooves 1 to 3 inches deep and no further apart than 10 to 12 inches.

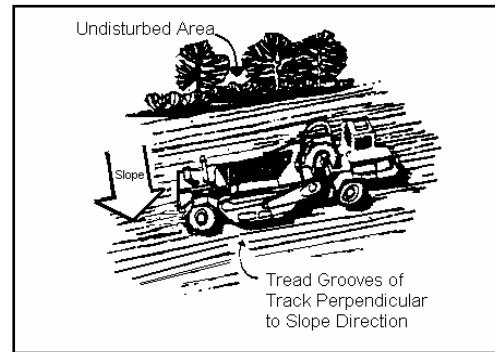

- Cut slopes that will not be mowed can either be step grading, the horizontal portion of each step must be longer than the vertical portion and should be sloped into the vertical portion. Individual vertical cuts should be no higher than 24 inches or 36 inches if the material is rocky.

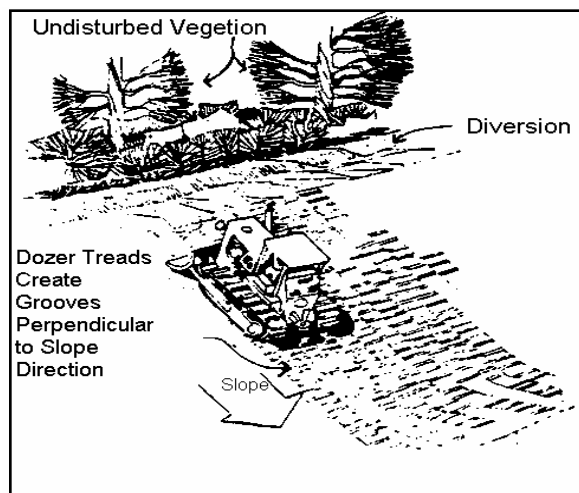

SEEDING CHART FOR THE STATE OF MISSISSIPPI

*For a more comprehensive vegetation schedule, see “Erosion Control, Sediment Control and Stormwater Management on Construction Sites and Urban Areas (Three Volumes)”

SPECIES	SEEDING RATE/ACRE	PLANTING TIME	DESIRED pH RANGE	FERTILIZATION RATE/ACRE	METHOD OF ESTABLISHMENT	ZONE OF ADAPTABILITY	NATIVE/INTRODUCED
Common Bermuda	15 lbs. alone 10 lbs. mixture	3/1 - 7/15 9/1 - 11/30	6.0 - 7.0	600 lbs. 13-13-13	seed or sod	All	Introduced *Potential for Invasiveness
Bahia	40 lbs. alone 30 lbs. mixture	3/1 - 7/15 9/1 - 11/30	6.0 - 7.0	600 lbs. 13-13-13	seed	Central & South	Introduced
Fescue	40 lbs. alone 30 lbs. mixture	9/1 - 11/30	6.0 - 7.0	600 lbs. 13-13-13	seed	North & Central	Native
Saint Augustine	--	3/1 - 7/15	6.0 - 7.0	600 lbs. 13-13-13	sod only	Central & South	Native
Centipede	4 lbs. alone 2.5 lbs. mix	3/1 - 7/15	6.0 - 7.0	600 lbs. 13-13-13	seed or sod	All	Introduced
Carpet Grass	15 lbs. alone 10 lbs. mixture	3/1 - 7/15	6.0 - 7.0	600 lbs. 13-13-13	seed or sod	All	Native
Zoysia Grass	--	3/1 - 7/15	6.0 - 7.0	600 lbs. 13-13-13	sod only	All	Introduced
Creeping Red Fescue	30 lbs. alone 22.5 lbs. mix	9/1 - 11/30	6.0 - 7.0	600 lbs. 13-13-13	seed	All	Native
Weeping Lovegrass	10 lbs. alone 5 lbs. mix	3/1 - 7/15	6.0 - 7.0	600 lbs. 13-13-13	seed	All	Introduced
Sericea Lespedeza	40 lbs.	3/1 - 7/15 9/1 - 11/30	6.0 - 7.0	400 lbs. 6-24-24	seed	All	Introduced
*Wheat	90 lbs. alone	9/1 - 11/30	6.0 - 7.0	600 lbs. 13-13-13	seed	All	Native
*Ryegrass	30 lbs.	9/1 - 11/30	6.0 - 7.0	600 lbs. 13-13-13	seed	All	Native
*White Clover	5 lbs.	9/1 - 11/30	6.0 - 7.0	400 lbs. 6-24-24	seed	All	Introduced
*Crimson Clover	15 lbs.	9/1 - 11/30	6.0 - 7.0	400 lbs. 6-24-24	seed	All	Introduced
*Hairy Vetch	30 lbs.	9/1 - 11/30	6.0 - 7.0	400 lbs. 6-24-24	seed	All	Introduced
*Browntop Millet	40 lbs. alone 15 lbs. mix	4/1 - 8/30	6.0 - 7.0	600 lbs. 13-13-13	seed	All	Introduced

*Note on Annuals. For permanent seeding, annuals can only be used in a mixture with perennials.

North-north of Hwy. 82

Central- south of Hwy. 82 & north of Hwy. 84

South- south of Hwy. 84

2. **Structural Controls** divert flows away from disturbed areas, reduce runoff velocities, filter out sediment and remove sediment by ponding. Temporary structures are installed before and during construction. After removing temporary storm water controls the area should be vegetated. Permanent structures remain after construction.

- **Diversion** ridges or channels of stabilized soil can divert off-site runoff from disturbed areas or sediment-laden runoff into sediment basins. If diversions will remain in place more than 30 days they should be covered with temporary or permanent vegetation. Diversions must have enough grade to assure drainage, but not enough

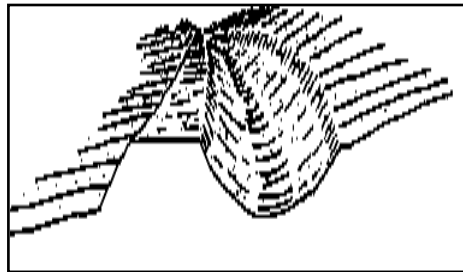
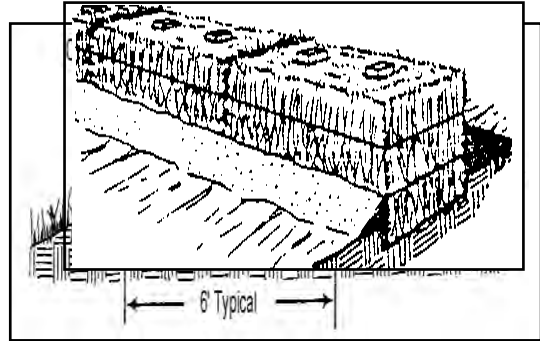

to cause erosion within the channel. Allow sufficient room around diversions to accommodate machine regrading, if needed. The maximum allowable drainage area is five acres.

- **Silt fences** are used below small disturbed areas to capture sediment from sheet flow. Eight inches of fence should be buried in a trench about four inches deep and four inches wide. **Silt fences that are not buried are improperly installed, have no useful function, are a waste of money, and could result in substantial fines.** The maximum slope length behind a fence is 100 feet with maximum gradient two horizontal to one vertical (2:1). Under no circumstances should silt fences be installed across flowing streams. They may be placed in minor swales or ditch lines where the maximum contributing drainage area is no more than two acres. The fence must be maintained and the sediment removed when deposits reach one-half the fence height. After the fence is no longer needed, the area should be graded, seeded and mulched.

Install fence steel fence posts or 4 inch diameter wooden posts that are five 5 feet in length. Posts should be installed starting at the center of the lowest point of the fence line and be driven 12 inches into the ground. Allow 6 inch overlap at joints. Machines that install silt fences are also acceptable methods of installation.

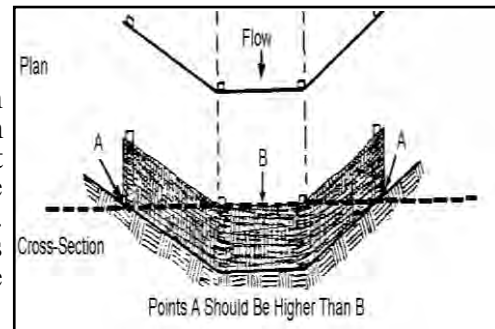

- **Straw bale barriers** are also used on small disturbed areas to capture sediment from sheet flow. The drainage area must be restricted to 1/8 acre per 100 feet of barrier. Maximum gradient behind the barrier is three horizontal to one vertical (3:1). The barrier must be located so that

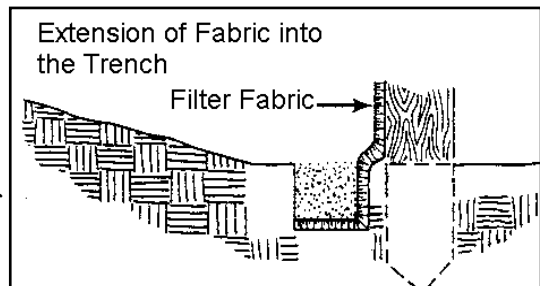

the water depth does not exceed one foot at any point. Straw bales, with bindings oriented around the sides, shall be entrenched a minimum of four inches and anchored with two stakes driven toward the previously laid bale. **Straw bales that are not buried are improperly installed, have no useful function, are a waste of money, and could result in substantial fines.**

- Bales should be placed so that the ends are tightly abutting each other. Bales should be staked down using 1" x 2" wood stakes or rebar. Use two (2) stakes per bale and angle the first stake towards the previously laid bale. Stakes should be long enough to go through the bale and into the ground a minimum of 12 inches.

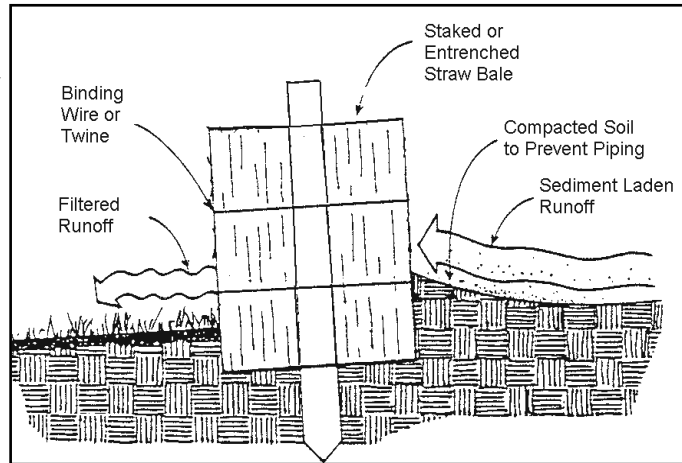

- Gaps between bales shall be wedged with straw. Loose straw scattered immediately uphill increases barrier efficiency. **Under no circumstances should straw bale barriers be constructed in live streams.** For minor dry swales, the end bale bottoms shall be higher than the middle bale top to assure runoff will not flow around the barrier. Repair damaged bales, end runs and undercutting. Remove sediment when it reaches one-half (1/2) barrier height. When upslope areas are stabilized, remove bales and grade, seed and mulch barrier line.

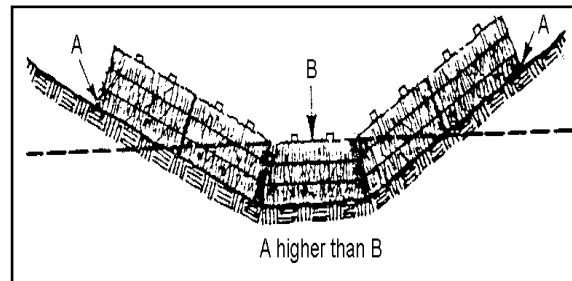

- **Storm drain inlet protection** is a sediment filter (aggregate, silt fence, straw bales, or manufactured filter) or an excavated sediment trap around a storm drain inlet. Storm sewers installed before their drainage area is stabilized can convey large amounts of sediment to streams. Straw bale and silt fence inlet protection are used for drainage areas of less than one (1) acre and slopes no greater than five percent (5%).

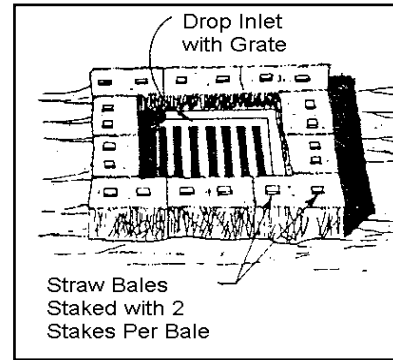
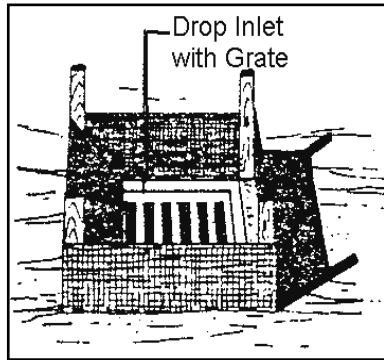

- **Sediment basins** allow sediment to settle out. Sediment basins are made by diking, excavating or a combination of the two. The “Erosion Control, Sediment Control and Stormwater Management” manual recommends a basin capacity of 134 yd³ per acre drainage area. Because of typical basin shapes and embankment side slope requirements of 2:1 or flatter, the capacity of the basin may be estimated by using the trapezoidal rule

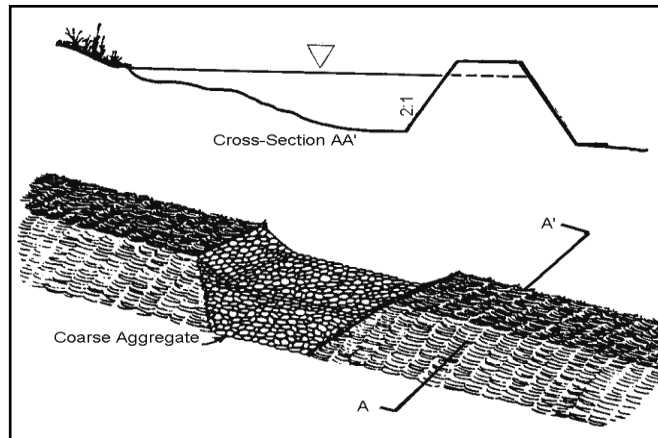

approximation of 40% x height x surface area. Sediment should be removed when the volume has been reduced to 67yd³ per acre drainage area. The length should be twice the width, with maximum surface area and outlet as far from the inlet as possible. If using a dike, it must be well compacted and vegetated, with an outlet pipe or coarse aggregate spillway. Install basins prior to construction but not in flowing streams and not in intermittent drains without a Corps of Engineers Permit. Use diversions to direct drainage to basins. Mississippi’s Large Construction Storm Water General Permit requires that a sediment basin be installed in any drainage location where more than 10 acres in the upstream basin are disturbed at one time. See planning and design manual for basin design details.

- **Flocculants** may be used in order to treat turbidity in construction site storm water discharges and incorporated as a part of an overall storm water management system. If flocculant application is proposed, the SWPPP must list the proposed flocculants to be used, describe the method, frequency and location of introduction, and identify the location of BMPs where flocculated material will settle. Flocculants must meet the criteria contained in ACT8 of the Large Construction General Permit and

implemented in accordance with the manufacturer's instructions.

- **Fiber logs (also known as wattles)** are rolls made of straw or coconut fiber placed inside plastic netting. Wattles can be good for reducing slope length on steep slopes, for very low gradient sites that are small, or for preventing sediment from leaving small stockpiles. A shallow depression is scraped out where the fiber log is staked down. Wattles can be used to protect a stockpile on a hard surface where no digging can take place, in which case the fiber log is laid on the surface ensuring that all ends are abutting tightly and fastened to each other. Sandbags or concrete blocks are used on the outside to prevent movement.

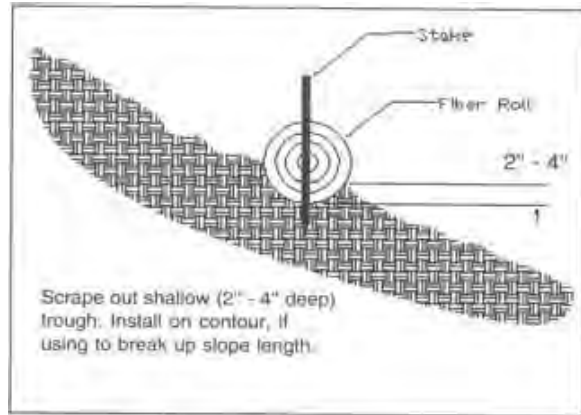

- **Slope drains** are piping or lined channels carrying storm water downslope without erosion. Runoff is directed to the drain by earthen diversion with a minimum height of 18 inches. At the inlet, the diversion and inlet cover must be six (6) inches higher than the top of the piping. The diversion and especially the inlet cover must be well compacted. Install piping hold-downs at 10-foot intervals and line the outlet area with riprap or other material to prevent scour and undermining. The maximum drainage area per drain should be five (5) acres. Permanent slope drains would be subsurface or paved flumes.

SIZE OF SLOPE DRAIN
Maximum Drainage
Piping Diameter

<u>Area (Acres)</u>	<u>(Inches)</u>
0.5	12
.75	15
1.5	18
2.5	21
3.5	24
5.0	30

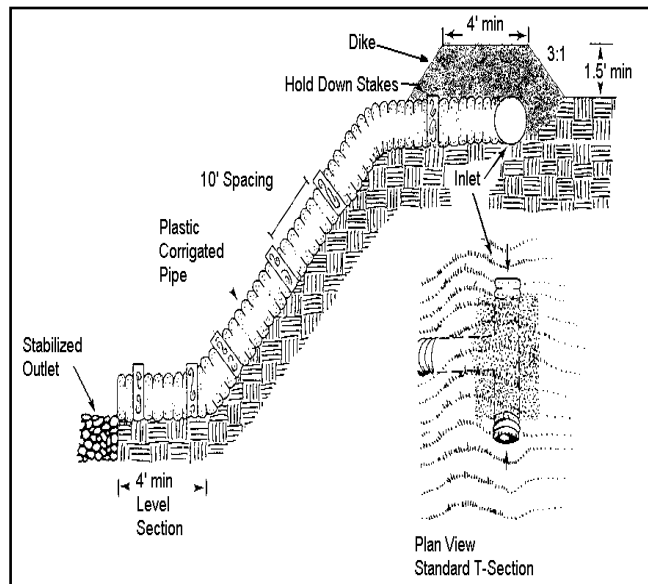

- **Slope breaks**, diversions or benches, are used to reduce the slope length of a cut or fill to minimize rill erosion and prevent gulying. Drainage area should be less than one (1) acre.

Slope Breaks	
Slopes	Spacing (ft)
Steep Slopes	
2:1	20
3:1	35
4:1	45
Gradual Slopes	
15 - 25%	50
10 - 15%	80
6 - 10%	125
3 - 6%	200
<3%	300

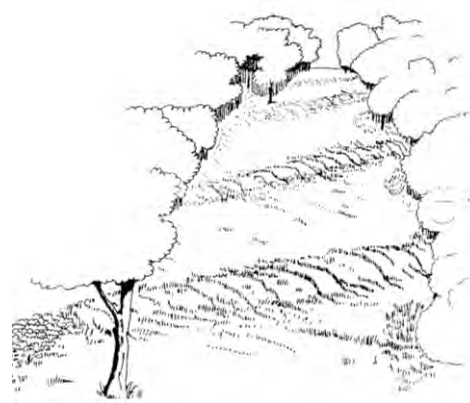

- **Riprap outlet protection** is placed at the outlet end of culverts or channels to reduce the depth, velocity and energy of water so that the flow will not erode the receiving downstream reach.

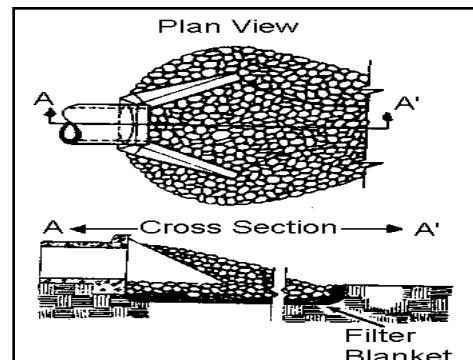

- **Check dams** are small dams constructed across swales or drainage ditches to reduce flow velocity and erosion. The purpose of a check dam is to prevent erosion of the swale or drainage ditch. They are not used in streams. Check dams can be constructed of stone, straw bales, or logs, with a maximum height of two (2) feet. **The check dam center must be at least six (6) inches lower than the outer edges to prevent erosion around the edges.**

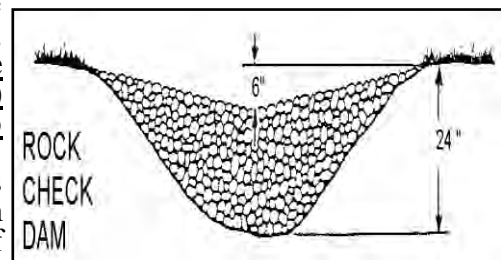

The maximum spacing between dams should be such that the toe of the upstream dam is at the same elevation as the top of the downstream dam. Sediment will accumulate and should be removed from behind the check dams when it reaches one half the dam height. Erosion around dam edges should be corrected immediately, ensuring that the dam center is six (6) inches lower than the edges. In grass-lined ditches, grass must be established prior to dam removal. The dam site should be seeded and mulched or sodded, as needed. The use of check dams should be limited to small open channels that drain 10 acres or less.

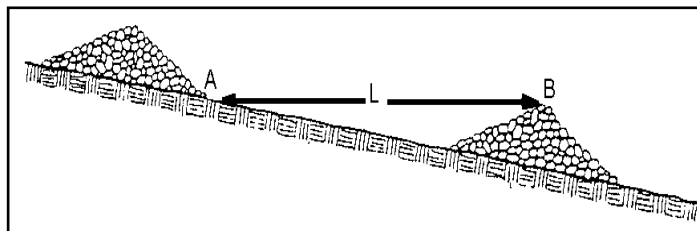

- **Construction entrance/exits** are stone stabilized site entrances which reduce sediment transferred onto public roads. Aggregate should be at least six (6) inches thick and 50 feet long. Tire washing may also be needed.

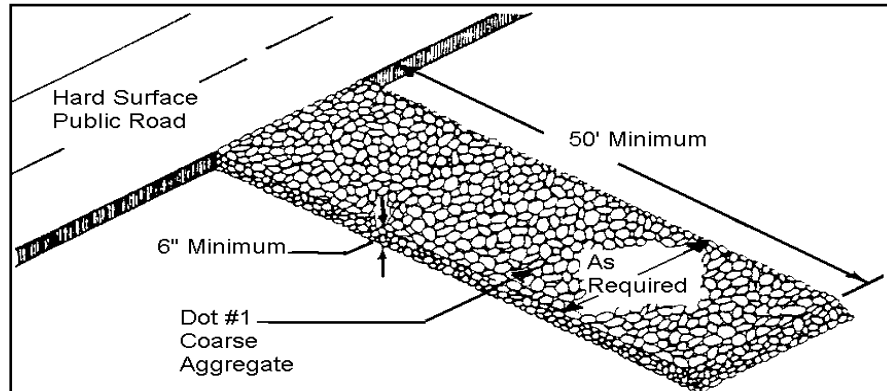

- **Level spreaders** are diversion outlets allowing the flow to disperse uniformly over surrounding vegetated areas. Spreaders should be constructed on undisturbed soil with downstream areas having established vegetation. Used to divert upslope waters around disturbed areas.

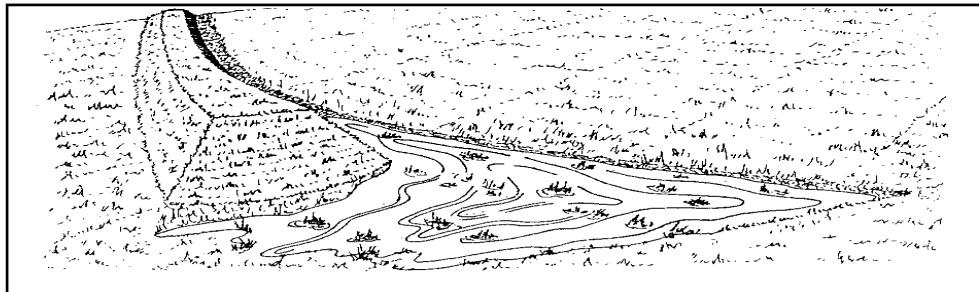

3. **Controls for individual lots in subdivisions and commercial developments.** The Large Construction Storm Water General Permit specifies that individual lots within residential and commercial developments, “that are part of a larger common plan of development or sale” are regulated regardless of size or owner. Therefore, requirements have been established for commercial and residential lots regarding storm water pollution prevention for lots and parcels that are sold by the original coverage recipient.

Commercial development: The original coverage recipient responsible for all construction activities until individual lots or parcels within the development are sold to others and the new owner submits a Large Construction Notice of Intent, SWPPP and obtains coverage. For commercial development, a SWPPP must be developed and submitted along with the LCNOI.

Residential Subdivision: The original coverage recipient is responsible for construction activities until the new owner or operator submits the Registration Form for Residential Lot Coverage and develops and implements a sediment and erosion control plan, submits a LCNOI and required documents, or applies for an individual storm water permit. Homebuilders are required to minimize off-site damage from soil erosion, sediment leaving the construction site, and poor "housekeeping" practices. Examples of individual lot sediment and erosion control plans are attached for your convenience. Sketch the controls on a copy of your site plan. Narrative notes on the site plan may also be used in addition to the erosion control symbols. In developing and implementing the plan, controls must be used from each control group (vegetative, structural, housekeeping) to prevent erosion and sediment and other pollutants from leaving the site.

4. **Housekeeping Practices.** Pollutants that may enter storm water from construction sites because of poor housekeeping may include, but are not limited to oils, grease, paints, gasoline, solvents, litter, debris, and sanitary waste.

The SWPPP should:

- designate areas for equipment maintenance and repair;
- designate areas for equipment wash off (i.e., concrete chute wash off);
- provide waste receptacles at convenient locations and provide regular collection of waste;
- provide adequately maintained sanitary facilities;
- provide protected storage areas for chemicals, paints, solvents, fertilizers, and other potentially toxic materials;
- implement spill and leak prevention practices and response procedures if spills and leaks do occur; and
- minimize the exposure of building materials, building products, construction wastes, trash and landscape materials.

5. **Post - Construction/Storm Water Management Measures.** The Storm Water Construction General Permits require that the SWPPP describe any measures that will be installed and implemented to control pollutants in storm water after construction is complete. These controls include, but are not limited to, one or more of the following:

- **Detention ponds** detain runoff in a basin for a limited time releasing it slowly, allowing sediment to drop out.

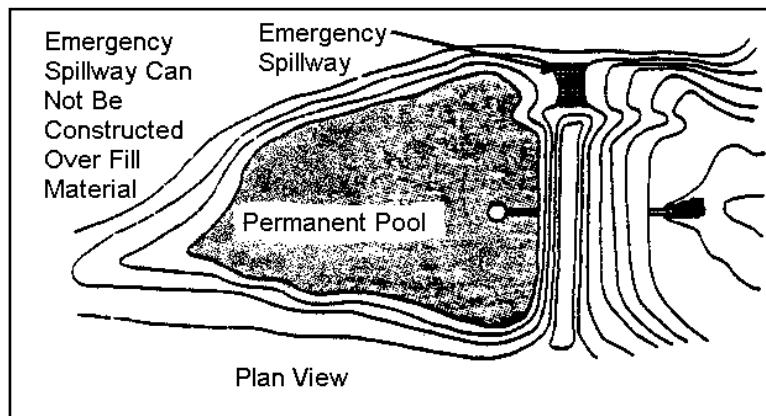

- **Retention Ponds** provides complete onsite storage and treatment of a specific volume of storm water runoff by using infiltration and evaporation. The specific volume is typically the first inch or half inch of storm water runoff containing the first flush of pollutants.

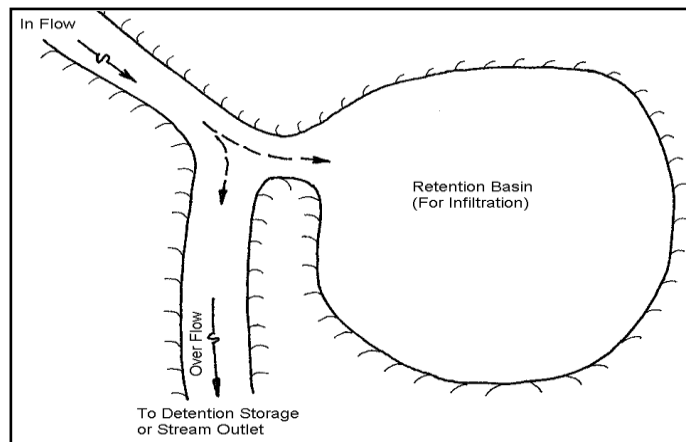

- **Constructed wetlands** are modified natural or constructed shallow basins for treatment of waters by wetland vegetation. Constructed wetlands are operated wet. They can achieve a high removal rate of sediments, BOD, organic nutrients and metals. They can also create wildlife habitat, recreation, and landscape amenities as well as corresponding higher property values.
- **Vegetated swales and natural depressions** are grass-lined, filtering sediments from the runoff and preventing erosion. Vegetated swales should have side slopes of 4:1 or flatter.
- **Velocity dissipation devices** prevent erosion from high runoff velocity, such as **riprap** placed at the discharge point.
- **Exfiltration trenches** are a feasible option where soils are permeable and the water table is well below the surface. Exfiltration trenches retain storm water for release into the soil. Storm water runoff is temporarily stored in perforated pipe or coarse aggregate and allowed to infiltrate the trench walls and, to some extent, trench bottoms. Trenches require regular maintenance to prevent clogs.

PART III

PREPARE SWPPP

1. **Write a Description of Controls.** Once you have finished selecting the vegetative and structural controls, list each control you plan to implement. There are specific controls in the construction permits that must be implemented unless infeasible.
2. **Prepare a scaled site map** showing:
 - Boundaries of property and proposed construction activities, noting any phasing of construction activities,
 - Original and proposed contours (if feasible), with steep slopes identified
 - North arrow
 - Drainage pattern arrows
 - Location of sensitive areas, such as wetlands, perennial streams and adjacent receiving water bodies, (if the receiving waterbody is not depicted on the map, the name and direction shall be listed in text form on the map)
 - Location of any storm drain inlets and any receiving MS4
 - All erosion and sediment controls (vegetative and structural)
 - Any post-construction control measures, and
 - Location of housekeeping practices

If the construction project is a linear construction project (e.g., pipeline, highway, etc.), a scaled site map is not required, however standard diagrams (e.g., cross sections showing dimensions and labeled components of erosion and sediment controls to be used must be submitted.

3. **Implementation Sequence.** Indicate the order in which activities will take place. When work is discontinued for 14 days or more in a disturbed area or completed, appropriate vegetative and structural practices must be initiated immediately. Several general implementation principles are:
 - **Install** downslope and perimeter controls before other site work. Build sediment basins before major site grading.
 - **Divert** upslope water around area before major site grading.
 - **Do not disturb** an area until it is necessary.
 - **Time** construction activities to limit impact from seasonal weather.
 - **Cover or stabilize** disturbed areas as soon as possible.
 - **Do not remove** temporary controls until after site stabilization.
4. **Inspection and Maintenance Schedules.** A description of an inspection and maintenance schedule for all disturbed areas, material storage areas, and erosion and sediment controls that were identified as part of the plan shall be included in the SWPPP. Non-functioning controls shall be repaired, replaced or supplemented with functional controls within 24 hours of discovery or as soon as field conditions allow. During permit coverage all erosion controls must be inspected at least once per week for a minimum of four (4) inspections per month and as often as necessary to ensure that appropriate erosion and sediment controls have been properly constructed and maintained and determine if additional or alternative control measures are required. The MDEQ strongly recommends that coverage recipients perform a “walk through” inspection of the construction site before anticipated storm events. Controls must be in good operating condition until the area they protect has been completely stabilized and the construction activity is complete. The SWPPP must also identify all allowable source of non-storm water discharges listed in ACT2, T-2 of the Large Construction Storm Water General Permit, except for flows from actual fire fighting activities, which are combined with storm water discharges associated with large construction activity. The inspection

information must be recorded on the forms developed and provided by the MDEQ. These forms are available on the General Permits Branch page found at:
http://www.deq.state.ms.us/MDEQ.nsf/page/epd_epdgeneral?OpenDocument

PART IV

APPLY FOR PERMIT COVERAGE

The MDEQ now has two different storm water general permits that cover construction activities in Mississippi. Construction activities that disturb one acre to less than five acres require coverage under the Small Construction General Permit. The requirements of the Small Construction General Permit are similar to the Large Construction General Permit. However, there is one fundamental difference. **The Small Construction General Permit has no submittals to the MDEQ unless specifically requested.** The owner or operator must complete the Small Construction Notice of Intent (SCNOI) and keep the form on the project site or locally available. In addition, the owner or operator must develop and implement a Storm Water Pollution Prevention Plan (SWPPP). The SWPPP must also be kept at the project site or locally available.

For projects that are considered large construction activities, the owner or operator must submit a Large Construction Notice of Intent (**LCNOI**) to the Office of Pollution Control (OPC) along with the **SWPPP** and the **USGS Quad Map** (or copy). The LCNOI summarizes information about you, your site, the prime contractor, and receiving water(s). The LCNOI is due at least 30 days prior to the commencement of construction. An **authorized representative**, as described in the general permit, must sign the LCNOI. If the owner signs the LCNOI and will not serve as the prime contractor, the prime contractor should sign and submit the Prime Contractors Certification form provided in the LCNOI prior to actual construction.

Operators of construction sites should keep in mind that local governments (cities, towns, counties) often have their own requirements for construction sites. Compliance with local requirements does not mean compliance with state requirements or vice versa. Forms may be found on our website at:

http://www.deq.state.ms.us/MDEQ.nsf/page/epd_epdgeneral?OpenDocument

PART V

IMPLEMENT CONTROLS

Erosion and sediment controls shall be constructed and the stabilization measures shall be applied in the order that was indicated in the implementation sequence. It is important that appropriate construction workers are aware of the SWPPP and have ready access to it. The owner or prime contractor must **inspect and maintain** controls, recording damages or deficiencies and corrective measures, and **complete monthly inspection reports** using the form provided by the MDEQ. Problems should be corrected within 24 hours or as soon as practicable after an inspection. Changes to correct deficiencies in the SWPPP should also be made as soon as practicable after the inspection. The SWPPP must accurately reflect the site and construction and be corrected if it does not.

PART VI

STABILIZE SITE & TERMINATE COVERAGE

Upon successful completion of all permanent erosion and sediment controls for a Large Construction project, the Office of Pollution Control must be notified by submission of a Request for Termination of Coverage (RFT) form. The RFT form must be fully completed by both the owner and operator and include original signatures by both parties. The RFT form is provided in the Storm Water Large Construction General Permit. If the entire RFT form is fully completed and the MDEQ on site inspection does not show any problems, a letter will be sent to the coverage recipient stating the permit has been terminated. At this point, the permittees are relieved of their responsibility. Failure to submit the RFT is a permit violation and subject to enforcement action.

SAMPLE STORM WATER POLLUTION PREVENTION PLAN (SWPPP)

Site Information

The construction of two commercial buildings and associated pavements will disturb 7.2 acres. Three-fourths of this site has a medium erosion hazard. The remainder of the site has 10 to 20 percent slopes that are highly erodible. An intermittent drain on the north end of the property drains the site to "Any-Name" Creek. "Any-Name" Creek stream is not on the 303(d) list for siltation, turbidity or habitat alterations, therefore additional controls that are warranted for a site discharging to listed receiving streams are not required.

Controls

Vegetative Controls: A 15-foot undisturbed vegetative buffer zone will be maintained around the perimeter of the site. Existing trees will be preserved where possible. All diversions will be seeded (permanent seeding) within seven calendar days of construction. Topsoil will be stockpiled for use in landscaping. Grass-lined waterways will be constructed and lined with temporary straw-net liners and will be constructed around both buildings. All 3:1 cut slopes will be roughened by disking prior to seeding. The slope on the south side of the intermittent stream will be sodded with Bermuda grass. Any disturbed areas that will be left undisturbed for 14 or more days will be seeded (temporary seeding) immediately. After final grading, all disturbed areas will be seeded (permanent seeding) immediately.

Structural Controls: A sediment basin with a surface discharge will be constructed at the end of the existing intermittent drainage to the north (drainage area: 4.8 acres). A sediment basin will be constructed at the southwest corner of the property where runoff leaves the property. Storm water will be directed to these basins with the assistance of diversions and grassed waterways. Upslope waters will be diverted around disturbed areas. A level spreader will serve as the outlet for the diversion southeast of the buildings. All cut slopes will be at or below a 3:1 grade. A construction entrance will be built and any accumulation of mud on vehicle tires will be washed, if needed, during muddy conditions. Inlet protection (silt fences) will be installed at all storm drain inlets. A silt fence will be constructed around the stockpile. The eroding natural drainage way on the north end of the site will be lined with rip rap (which is covered by a Nationwide Permit # 13 – *an individual 404 Permit is not required because the activity is less than 500 linear feet and has less than 1 cubic yard of rip rap per linear foot - no notification of Corps required.*). Riprap will be placed at all culvert outlet aprons. A sediment pit will be excavated for concrete trucks to wash the mixer chutes and a memo will be sent to the concrete supplier to use a minimum amount of water. Drivers will be instructed to return any materials to the concrete batch plant and complete final washing procedures at that location.

Housekeeping Practices. All equipment maintenance and repair will be done offsite. Trash cans will be placed at convenient locations throughout the site. The main trash collection bin will be located on the northeast corner of the site and will be picked up weekly by the city. Paints, solvents, fertilizers, or any other potentially toxic materials will not be stored onsite. Portable sanitary facilities will be provided for construction workers. There is a marked and designated area for concrete truck wash off.

Post Construction/Storm Water Management Measures: The temporary sediment basin will be converted to a detention basin after construction. Riprap will be placed at concentrated storm water discharge points to prevent erosion from high runoff velocities.

Implementation Sequence

1) build construction entrance/exit. 2) install sediment basin with needed riprap. 3) contour and riprap intermittent drainage way to the north. 4) rough grade site, construct diversions and drainage ways, stockpile topsoil and install silt fence around stockpile, install culverts with inlet/outlet protection (silt fence), level spreader and riprap. 5) plant needed temporary vegetation on disturbed areas. 6) construct buildings and parking lots. 7) finish slopes around buildings, roughen slopes and vegetate. 8) after site is stabilized, remove all temporary measures, vegetating these areas, and convert sediment basin to a detention basin.

Maintenance Plan

Check all disturbed areas, erosion and sediment controls after each significant rainfall but not less than once per week. Make needed repairs within 24 hours. Remove sediment from the basin, inlet protection devices and silt fences when accumulated sediment has reached 50 percent capacity. Replace non-functional silt fence. Maintain all vegetated areas to provide proper ground cover - reseed, fertilize, and mulch as needed.

SAMPLE SITE MAP

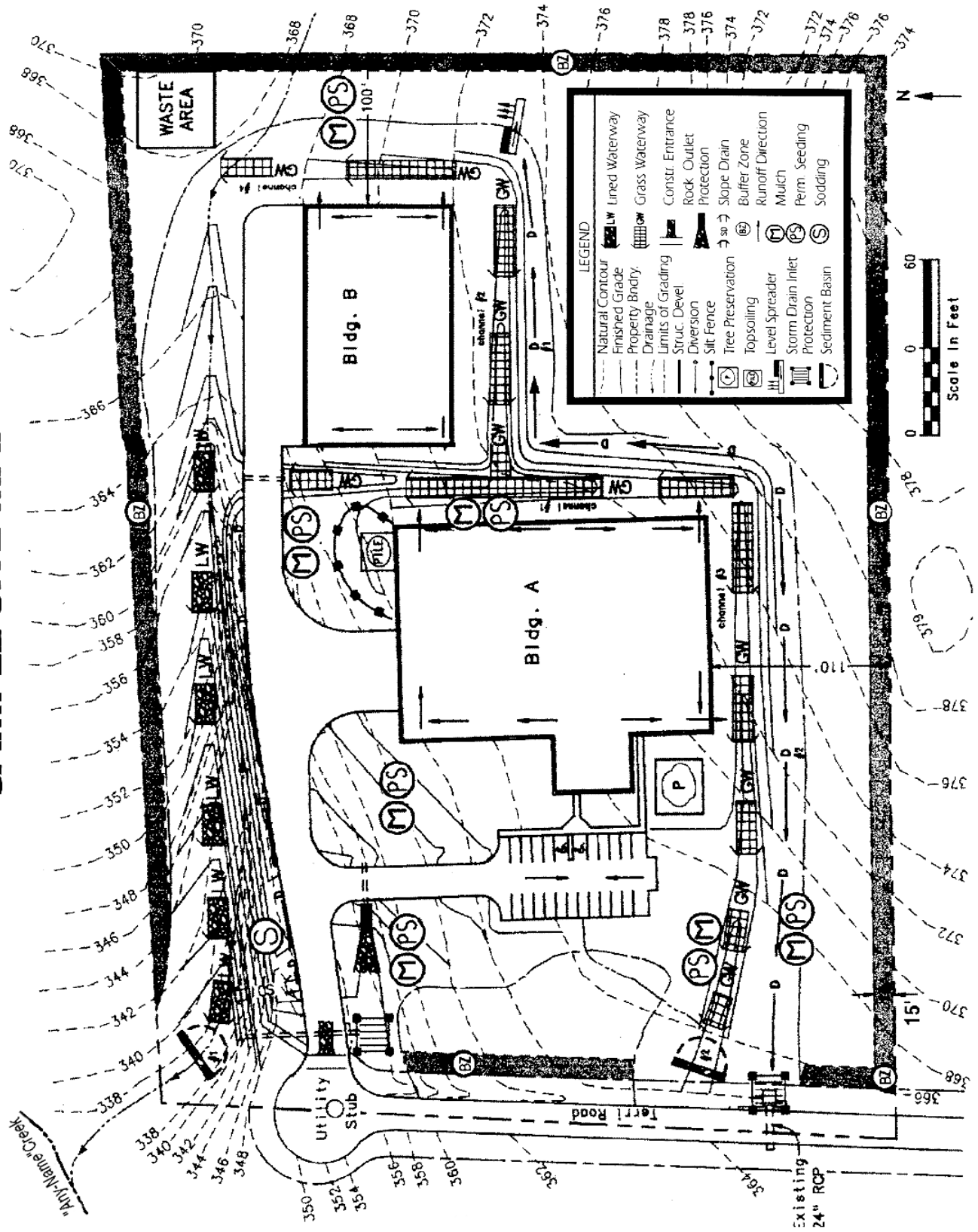

COMMON PLAN OF DEVELOPMENT OR SALE SWPPP REQUIREMENTS FOR INDIVIDUAL LOTS IN A RESIDENTIAL SUBDIVISION

When rain falls on exposed soil it can wash away valuable topsoil. It also carries soil, nutrients and other pollutants into streets, gutters and ditches, where it then travels to lakes, rivers, streams or wetlands. Polluted runoff can cause excessive growth of aquatic weeds and algae and reduce recreational opportunities such as swimming and fishing. Sediment laden runoff can also destroy fish habitat reducing productive fishing opportunities. In addition, sediment-laden runoff can also clog pipes, ditches, streams and basins resulting in increased flooding and maintenance cost. Therefore, the homebuilder is required to minimize off-site damage from soil erosion, sediment leaving the construction site, and poor "housekeeping" practices. This requirement must be accomplished by developing and implementing a Storm Water Pollution Prevention Plan (SWPPP). Some examples of individual lot SWPPPs are attached for your convenience. Sketch the controls on a copy of your site plan. Narrative notes on the site plan may also be used in addition to the erosion control symbols.

In developing and implementing the SWPPP, controls must be used from each control group (vegetative, structural, housekeeping) to prevent erosion and sediment and other pollutants from leaving the site. Commonly used controls include:

Vegetative Controls

Temporary vegetation includes annual grasses that sprout quickly such as annual rye, browntop millet, oats, and winter wheat. These grow quickly with little care and can protect the soil from rainfall and act as a filter. They will not provide permanent cover. Permanent cover must be established as soon as possible. When a disturbed area will be left undisturbed for fourteen days or more, the appropriate temporary or permanent vegetative practices shall be implemented immediately.

Mulching is the placement of hay grass, woodchips, straw, or synthetic material on the soil to provide temporary cover to protect the soil from rain. Mulching may be the only option during the winter when seeding or sodding is not possible. Mulch must stay in place to be effective. Netting, stakes or chemical binders are used to anchor some types of mulch. Be sure to reinstall washed-out mulch and anchor if necessary until permanent cover is established.

Permanent stabilization is required as soon as possible. Silt fences, and other temporary measures must be removed following permanent stabilization. Establishing a permanent vegetative cover on disturbed areas using either sod, perennial seed, trees or shrubs is required. When a disturbed area will be left undisturbed for thirty days or more, the appropriate temporary or permanent vegetative practices shall be implemented within seven calendar days.

Vegetative buffer zones are undisturbed or planted vegetated areas that are between construction activities and water bodies, street, drainage ditch, etc. A 15-foot wide buffer is recommended.

Structural Controls

Silt fences are temporary sediment barriers made of filter fabric buried at the bottom, stretched, and supported by stakes. The silt fence slows runoff and allows it to puddle or pond, so soil and sediment can settle out before leaving the site. The bottom eight to twelve (8-12) inches of fence must either be sliced in or buried in a trench about four to six (4-6) inches deep by four to six inches wide. **Silt fences that are not buried are improperly installed. They have no useful function, are a waste of money, and may result in enforcement action.** Stakes must be on the downstream side of the fence and spaced about three (3) feet apart. Silt fence must not be installed across streams, ditches, waterways, or other concentrated flow areas. Place fences on the contour or perpendicular to the slope of the hill so that water and sediment will pond behind the fence. **Turn ends uphill** to prevent water going around the end. Install on the downslope, downhill, downstream, or low side of your lot. Keep the fence/barrier in place until grass is established.

Construction entrance/exits are stone stabilized site entrances which reduce sediment tracked onto public roads. Apply gravel or crushed rock to the driveway area and restrict traffic to this one route. Use 3 to 6 inch gravel over a geotextile fabric. At the end of each day sweep or scrape up any soil tracked onto the street. Limit "standard" vehicle access (including workers' vehicles) to only streets and roads, keep vehicles off of future yard areas; limit tracking of mud onto streets by requiring any required vehicles to use designated access drives. Streets are conduits for storm water, it is important to keep mud and sediment off the streets.

Stockpiles of sand or soil should be covered with plastic or tarps at the end of each workday, or surrounded with silt fence or haybales. Do not locate a stockpile near a street, storm drain inlet, or ditch.

Slope drains are piping or lined channels that carry storm water downslope without erosion. A good example would be a downspout extender. Extenders may be used to protect temporarily stabilized areas from roof runoff. Extenders can direct water from roof gutters to paved or grassed areas. Remove extenders following permanent stabilization.

Erosion control blankets or mats are machine-produced mats of straw or other fibers held together with netting that provide temporary or permanent stabilization in critical areas, such as slopes or channels, so that vegetation may be established.

Additional Controls: The above controls are the more common practices used at small construction sites. There are a number of other controls, techniques and manufactured product available. A few examples include hydro seeding, inlet protection devices, diversion berms, silt dikes and fiber logs. Even something as simple as a tarp or plastic may provide temporary cover for small exposed areas. You may wish to contact an erosion and sediment control specialist, local building official, or MDEQ for further information. In addition, MDEQ has several guidance manuals that may be of assistance and the internet has abundant guidance on construction BMPs.

Housekeeping Controls

Pollutants that may enter storm water from construction sites because of poor housekeeping include oils, grease, paints, gasoline, solvents, litter, debris, and sanitary waste. Good housekeeping practices include:

- Minimize the exposure of building materials, building products, construction wastes, trash and landscape materials
- Frequent cleaning of trash and debris, providing waste receptacles at convenient locations and providing regular collection of waste;
- Directing concrete trucks to the subdivision's designated wash-off area(s) or back to the Ready-Mix facility;
- Providing protected storage areas for chemicals, paints, solvents, fertilizers, and other potentially toxic materials; and
- Providing adequately maintained sanitary facilities.

In addition, you should be aware that State air regulations prohibit the open burning of residential solid waste.

EXAMPLE INDIVIDUAL LOT SITE MAPS

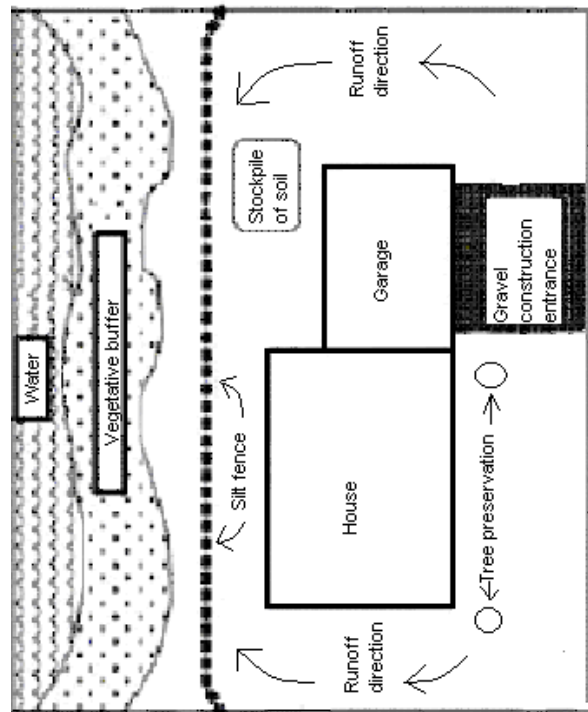
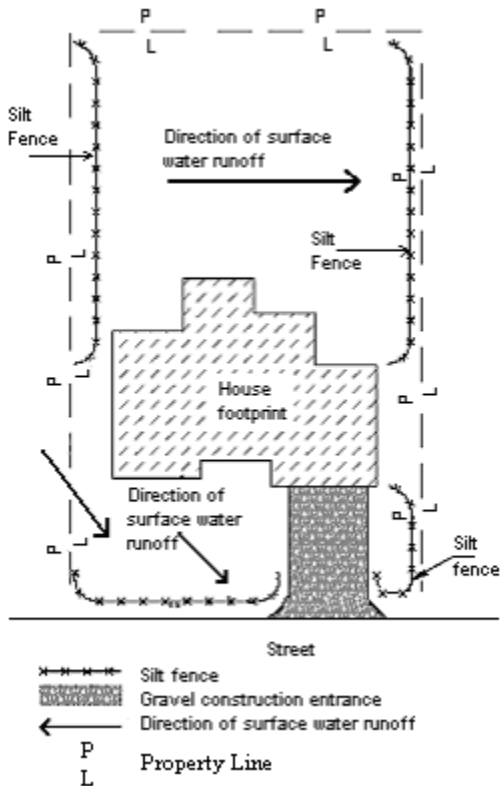
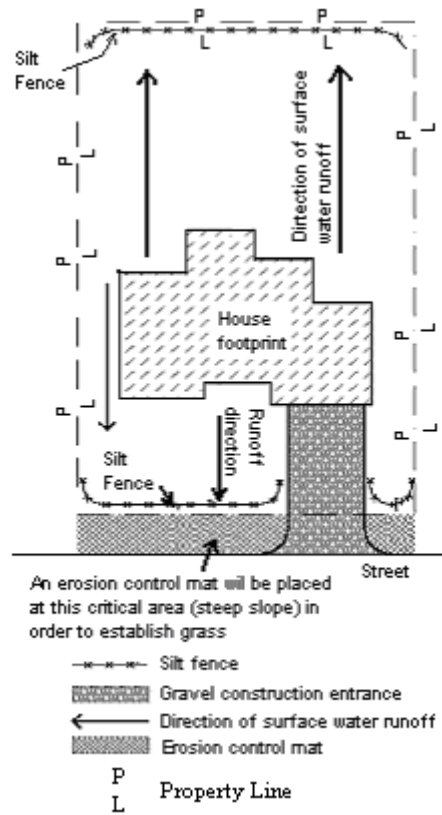
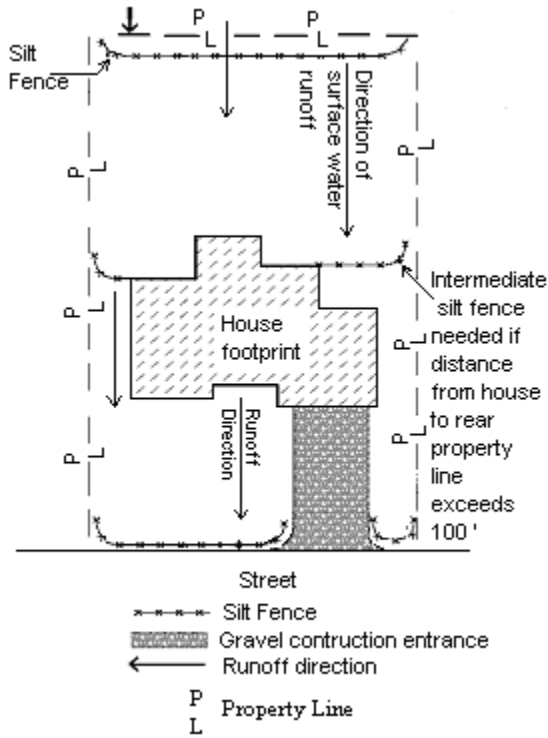

All disturbed areas will be temporarily seeded with ryegrass. After final grade has been reached, all disturbed areas will be sodded with bermuda grass.

Worksheet 1 - Checklist Sheet for Erosion and Sediment Controls

To aid in choosing all needed controls, check off practices to be used. Describe in SWPPP and show locations on site map.

STRUCTURAL PRACTICES

- | | |
|---|---|
| <input type="checkbox"/> Check Dam | <input type="checkbox"/> Construction Entrance/Exit |
| <input type="checkbox"/> Diversion | <input type="checkbox"/> Storm Drain Inlet Protection |
| <input type="checkbox"/> Level Spreader | <input type="checkbox"/> Lined Waterway |
| <input type="checkbox"/> Slope Drains | <input type="checkbox"/> Rip-Rap Outlet Protection |
| <input type="checkbox"/> Sediment Basin | <input type="checkbox"/> Silt Fence |
| <input type="checkbox"/> Slope Breaks | <input type="checkbox"/> Straw Bale Barrier |
| <input type="checkbox"/> Other Controls _____ | |

VEGETATIVE PRACTICES

- | | |
|---|--|
| <input type="checkbox"/> Mulching | <input type="checkbox"/> Permanent Seeding |
| <input type="checkbox"/> Protection of Trees | <input type="checkbox"/> Surface Roughening |
| <input type="checkbox"/> Sod Stabilization | <input type="checkbox"/> Temporary Seeding |
| <input type="checkbox"/> Tree Preservation | <input type="checkbox"/> Tillage, with Lime and Fertilizer |
| <input type="checkbox"/> Vegetative Buffer Strips | |
| <input type="checkbox"/> Other Controls _____ | |

CONTROLS FOR INDIVIDUAL LOTS IN SUBDIVISIONS

- | | |
|--|--|
| <input type="checkbox"/> Subdivision Covenants | <input type="checkbox"/> Lot Purchase Contract |
| <input type="checkbox"/> Local Ordinance | <input type="checkbox"/> Architectural Review Requirements |
| <input type="checkbox"/> Other Controls _____ | |

HOUSEKEEPING PRACTICES

- Areas for maintenance and repair
- Waste receptacles
- Storage for toxic materials
- Sanitary facilities
- Concrete Washout Areas
- Other Controls _____

POST CONSTRUCTION CONTROL MEASURES

- Detention Basin
- Retention Pond
- Wetlands
- Velocity Dissipation Devices
- Vegetated Swales and Natural Depressions
- Other Controls _____

FREQUENTLY ASKED QUESTIONS

Q. Are there any fees associated with CNOI applications or permit coverage?

A. No. The MDEQ general permits do not require a fee at this time.

Q. What should I do if my general permit coverage expires and my project has not been completed?

A. If the permit is reissued or replaced with a new one before the current one expires, you will need to comply with whatever conditions the new permit requires in order to transition coverage from the old permit. This usually includes submitting a re-coverage form that will be sent to you along with a letter of instruction and a copy of the reissued general permit. The MDEQ will contact you when a new permit is issued. You do not need to do anything until you are contacted.

Q. What is a SWPPP?

A. This acronym stands for Storm Water Pollution Prevention Plan. For construction activities, it is a plan which describes appropriate practices which will reduce erosion and mitigate sediment from leaving the construction site - an erosion and sediment control plan. See page 16 for instructions on preparing a SWPPP.

Q. Where can I get assistance?

A. If you do not have the expertise - hire an engineer or consultant who has knowledge of erosion and sediment control. Private land owners may go to the Natural Resource Conservation Service (NRCS).

Q. How do I terminate a project?

A.1. Within 30 days of final stabilization for a covered project, a completed Request for Termination (RFT) of Coverage form (provided in the Large Construction Forms Package) shall be submitted to the Permit Board. The MDEQ staff will inspect the site, and if no erosion or sediment control problems are identified and adequate permanent controls are established, the owner or operator will receive a letter of termination from the MDEQ.

A.2. The coverage recipient of a “larger common plan of development or sale” must submit a RFT within 30 days after the following conditions are met:

(1) Final stabilization has been achieved on all portions of the site for which the coverage recipient is responsible, and

(2) Other owners or operators have assumed control over all areas of the site that have not achieved final stabilization.

A.3. The coverage recipient of a residential “larger common plan of development or sale” must submit a copy of the MDEQ Registration Form for each lot sold with the RFT.

A.4. Residential lot owners or operators that have completed the MDEQ Registration Form are not required to submit a RFT, unless specifically requested by the MDEQ staff. The lot permit coverage is considered terminated upon successful completion of all permanent erosion and sediment controls.

- Q. What is the threshold of land disturbance that will require me to obtain storm water permit coverage?**
- A.1. Projects that are considered to be Large Construction are: land disturbing activities of five (5) acres or greater; or for land disturbing activities that are part of a larger common plan of development or sale that will disturb five (5) or more acres.
- A.2. Projects that are considered to be Small Construction are: land disturbing activities of one (1) acre to less than five (5) acres; or for land disturbing activities less than one (1) acre that are part of a larger common plan of development or sale that will disturb one (1) to less than five (5) acres.
- Q. What is meant by a “larger common plan of development or sale?”**
- A. A “larger common plan of development or sale” means a contiguous area where multiple separate and distinct construction activities are occurring under one plan. The plan in a common plan of development or sale is broadly defined as any announcement or piece of documentation (including a sign, public notice or hearing, sales pitch, advertisement, drawing, permit application, zoning request, computer design, etc.) or physical demarcation (including boundary signs, lot stakes, surveyor markings, etc.) indicating that construction activities may occur on a specific plot.
- Q. For projects such as a 100-mile pipeline project, what location should be provided on the CNOI?**
- A. The beginning of a linear construction project should be used as the location and all counties that the project traverses should be listed on the MDED’s CNOI Form.
- Q. Is clearing of lands specifically for agricultural purposes regulated construction activity (40 CFR 122.26(b)(14)(x)) under the storm water program?**
- A. No. Although the clearing of land may be greater than five acres, any amount of clearing for agricultural purposes is not considered an industrial activity under the storm water regulations. Section 402(l)(1) of the 1987 Water Quality Act exempts agricultural storm water discharges from NPDES permitting requirements including storm water permitting. This exemption only applies, however, if the clearing of land is solely for agricultural purposes. For example, the clearing of land for the purpose of building a retail store would be the beginning of construction activity and require permitting.
- Q. If a construction activity that disturbs less than one acre occurs at a regulated industrial activity currently covered by the State’s industrial storm water permit, does the regulated industry have to modify its pollution prevention plan to include controls for the area of construction?**
- A. Yes. Regulated industrial activities covered by Mississippi’s storm water industrial general permits must revise their pollution prevention plan to address all new sources of pollution and runoff including those from construction activities disturbing less than one acre, that occurred on the site of the regulated industry. If the disturbance is one (1) acres or greater then the facility should submit an NOI for coverage under the State’s construction storm water general permit.
- Q. For a construction activity that uses off site “borrow pits” for excavation of fill material or sand and gravel, should the number of disturbed acres at the borrow pit be added to the number of acres at the construction site to determine the total number of disturbed acres?**
- A. No, off site borrow pits are not considered part of the on site construction activity. If a borrow pit is specifically used for the removal of materials such as sand, gravel, and clay, the pit is considered

a mine and is classified under SIC code 14. Such sites would be regulated as industrial activity as defined at 40 CFR 122.26(b)(14)(iii).

Q. Who must apply for permit coverage for construction activities?

A. Under the Mississippi storm water program, the owner or operator of a regulated activity or discharge must apply for storm water permit coverage. The operator of a construction activity is the party or parties that either individually or taken together meet the following two criteria: (1) they have operational control over the site specifications (including the ability to make modifications in specifications); or (2) they have the day-to-day operational control of those activities at the site necessary to ensure compliance with plan requirements and permit conditions. Usually the owner of the project initially files the CNOI and the contractor would complete and submit the “prime contractor form” when selected.

Q. Who is responsible for permit compliance?

A. The owner and the operator have joint and severable liability for permit compliance.

Q. Does construction activity encompass repaving of roads?

A. Repaving is not regulated under the large construction storm water general permit unless five or more acres of underlying and/or surrounding soil is cleared, graded or excavated as part of the repaving operation.

Q. Does construction activity encompass routine road maintenance?

A. No. Construction activity does not include routine maintenance that is performed to maintain the original line and grade, hydraulic capacity, or original purpose of the site.

Q. Would building demolition constitute a land disturbing activity and require a storm water construction permit application?

A. The definition of land disturbing activity includes but is not limited to clearing, grading and excavation. At a demolition site, disturbed areas might include where building materials, demolition equipment, or disturbed soil are situated, which may alter the surface of the land. Therefore, demolition activities that disturb five or more acres of land would be subject to storm water construction permit application requirements.

Q. Do storm water construction general permits authorize non-storm water discharges?

A. The following non-storm water discharges are authorized: discharges from fire-fighting activities, fire hydrant flushing, water used to control dust, potable water including uncontaminated water line flushing, routine external building wash down that does not use detergents, pavement wash waters where spills or leaks of toxic or hazardous materials have not occurred (unless all spilled material has been removed) and where detergents are not used, uncontaminated air conditioning or compressor condensate, uncontaminated ground water or spring water, foundation or footing drains where flows are not contaminated with process materials such as solvents, uncontaminated excavation dewatering, landscape irrigation, water used to wash vehicles, wheel wash water and other wash waters where detergents are not use. However, they must be included in the SWPPP and addressed by the appropriate BMP.

APPENDIX E

FIELD MANUAL
FOR
EROSION
AND
SEDIMENT CONTROL
ON CONSTRUCTION SITES
IN
MISSISSIPPI

**Mississippi Department
of
Environmental Quality**



MISSISSIPPI DEPARTMENT OF ENVIRONMENTAL QUALITY

Second Edition 2005

**Written by James MacLellan, P.E., CPESC
Reviewed and Edited by Zoffee Dahmash, P.E.,
Chief of Nonpoint Source Section
Mississippi Department of Environmental Quality,
Nonpoint Source Section**

Acknowledgements

This Best Management Practices Manual was reviewed by the Environmental Compliance and Enforcement Division, the Natural Resources Conservation Service, and the Environmental Permits Division. A special thanks goes to Paul Rodrigue, Earl Mahaffey, Jim Morris, and Kenny Lafleur for their review and input.

Appreciation is also expressed to the State of Florida's Department of Environmental Protection and the International Erosion Control Association for providing resources, standards, and on-going education in the field of erosion and sediment control.

**Production of this manual was provided for by a Section 319
grant from the Environmental Protection Agency**

Preface

This manual has been prepared to assist those involved in the application of erosion and sediment control activities on construction sites. It should be helpful to contractors, construction foremen, equipment operators, inspectors, engineers, plan designers, and plan reviewers.

This manual is not a comprehensive list of all BMPs. It is intended to bridge the gap between design requirements, standards, and specifications contained in the Mississippi Planning and Design Manual for the Control of Erosion, Sediment and Stormwater¹ (on the web at <http://abe.msstate.edu/csd/p-dm/index.html>) and the actual installation and maintenance of structural and vegetative practices. It is designed especially to facilitate ease of handling and quick reference.

While this field manual will not replace the planning and design manual, it can be a useful supplement to information contained there. This field manual should be used in conjunction with the planning and design manual.

¹Available from:

Mississippi Department of Environmental Quality
Nonpoint Source Section
P. O. Box 2261
Jackson, MS 39201-2709
(601) 961-5171
(Call or write to request an order form)

TABLE OF CONTENTS

PAGE

1. INTRODUCTION	
A. Introduction	7
B. Basic Principles of Erosion and Sediment Control ...	9
C. Utilities Safety	10
2. EROSION CONTROL BMPs	
A. Check Dam	14
B. Construction Road Stabilization	18
C. Construction Sequence	20
D. Diversion	24
E. Level Spreader	26
F. Permanent Seeding	28
G. Pollution Source Controls	30
H. Soil Blanket (Mulch, Mats and Binders)	32
I. Temporary Seeding	36
J. Topsoiling	38
K. Tree Preservation	40
3. SEDIMENT CONTROL BMPs	
A. Buffer Zone	44
B. Construction Entrance	46
C. Dust Control	48
D. Floating Turbidity Barrier	50
E. Sediment Barrier	54
F. Stockpile Protection	58
G. Storm Drain Inlet Protection	60
H. Stream Crossing	66
I. Temporary Sediment Trap	68
4. SLOPE PROTECTION BMPs	
A. Slope Cover	72
B. Slope Drain	76
C. Slope Length Reduction	78
D. Slope Surface Roughening	80
5. INSPECTOR'S CHECKLIST AND TROUBLESHOOTING CHART	84
6. POINTS OF CONTACT	114
7. ADDITIONAL RESOURCES	116
8. TABLE OF SYMBOLS	117
9. GLOSSARY	118

**This page
intentionally
left blank**

Chapter 1

Introduction

**This page
intentionally
left blank**

Introduction

Purpose of this manual

The purpose of this manual is to provide a guide for contractors and inspectors on installing, maintaining, and inspecting erosion and sediment control BMPs. The BMPs in this manual do not require detailed design and are ones that should be commonly used on construction sites across Mississippi.

What is a BMP?

BMP is an acronym for Best Management Practice. BMPs are the most effective, economical, and practical way of reducing or preventing polluted runoff. BMPs can range from educating workers not to dump oil on the ground to clearing land in phases so that land not being worked on is protected from erosion. Many BMPs require changing the way something is done so that the same goal is accomplished while polluted runoff is minimized or eliminated. An example of this is driving a bulldozer up and down a slope rather than along the slope. Both ways accomplish the goal of grading a slope, however driving a bulldozer up and down creates small terraces that help capture runoff (thus controlling erosion) while driving a bulldozer along a slope creates small channels that speed up runoff and increase erosion.

Impacts of erosion and sediment

Every year, an estimated *400 million tons* of sediment erode from construction sites across the country and are carried into our nation's lakes, streams, rivers, and estuaries (SCS 1980). Every year, hundreds of acres are disturbed in Mississippi, contributing up to several thousand times the amount of sediment compared to adjacent undisturbed land. Large quantities of sediment result in great damage to the aquatic environment. The hydraulic capacity of rivers and ponds is decreased, thus resulting in hazards to river traffic and decreased natural flood storage capacity. This means more dredging, resulting in greater costs to local communities. Local stormwater conveyance systems become filled and culverts plugged, also resulting in greater costs to the local government. Excessive sediment on nearby public roads contributes to accidents.

The biological impacts of excessive sedimentation are even more devastating. Excessive sediment can fill in fish spawning areas, thus reducing the number of fish as well as the number of species. Excessive sediment in lakes and ponds will block sunlight, interfering with photosynthesis in the water and thus reducing the food supply for fish and other aquatic organisms. Excessive sediment can also clog fish gills or abrade them, killing or weakening the fish and making them more susceptible to disease.

Erosion and sediment problems are also destructive to wetlands. Uncontrolled erosion on construction sites can lead to the filling in of nearby wetlands. This is costly to the contractor who could be fined for filling in a wetland without a permit. It is also devastating to the environment, as wetlands are home to many species of birds, fish, mammals and other animals. Many species, particularly on the coast, use wetlands as spawning and nursery areas. Excessive sedimentation also reduces the ability of wetlands to filter and store runoff, thus increasing flooding and the release of pollutants into other waters.

Wetlands, streams, and other waters of the US must be avoided as much as possible in all construction or other earth-moving activities. Where avoidance is impossible, activities must be minimized and damage repaired.

Benefits of protecting our waters

Mississippi is a predominantly rural state where fishing and hunting are important outdoor activities. Many people do not make the connection between the large quantities of sediment in our waters and destruction of our fisheries. Nor do they think about the economic devastation that would result if our commercial and sport fishing were severely degraded due to water pollution. Extra work and costs to a community resulting from clogged drains and gutters could be avoided if BMPs are installed and maintained correctly on construction sites.

Use BMPs on construction sites. Use them correctly and maintain them well. Then all of Mississippi, including the contractor, will benefit in the long run.

Keep Mississippi Clean!
Keep Your Dirt On Your Own Site!

Basic Principles of Erosion & Sediment Control

- 1. Plan your Erosion and Sediment Control BMP installation in conjunction with your construction sequence.*
- 2. Controlling erosion is easier than controlling sediment.*
- 3. Remember that BMPs work best when several are used in a treatment train approach.*
- 4. Sediment control BMPs need to have erosion control BMPs installed ahead of them or the sediment control BMPs will quickly fail.*
- 5. Preserve existing vegetation wherever possible, especially trees.*
- 6. Install practices before exposing soil.*
- 7. Don't expose any more soil than necessary.*
- 8. Limit exposure of disturbed soils to the shortest time possible.*
- 9. Stabilize exposed soils with mulch or vegetation as soon as possible.*
- 10. Reduce water velocities across your site to prevent erosive flows.*
- 11. Divert any clean runoff flowing onto your site around your site.*
- 12. Transport runoff down steep slopes through lined channels or pipes.*
- 13. Keep your dirt on your own site.*
- 14. Make sure the runoff from your site is treated before it leaves your site.*
- 15. Maintenance, Maintenance, Maintenance!*

Utilities Safety - Mississippi One-Call System, Inc.

What does it do?



The excavator should call the Mississippi One Call Center (MOCC) two working days prior to beginning excavation (as per Mississippi law):

- MOCC will determine from the excavator the location of the excavation.
- MOCC will notify all Mississippi One Call System, Inc. (MOCS), Inc. members with underground facilities in the quarter section(s) where the excavation will take place.
- Members will either mark their facilities in the area of excavation or inform the excavator that they have no facilities in the area of excavation.
- All messages to and from the MOCC are recorded and maintained for a minimum of 48 months. This is done for the protection of both excavators and operators.

How much does it cost?

MOCC is free to excavators. Underground facility operators pay a membership fee which supports the computerized information center.

Proposed excavation

Use white marks to show the location, route or boundary of proposed excavation. Surface marks used on roadways should not exceed 1.5 inches by 18 inches (40mm by 450mm). The facility color and facility owner identity may be added to white flags or stakes.

Markings / Flagging



RED: Electric power lines and esoduits



YELLOW: Gas, oil, petroleum products and all other hazardous liquid or gaseous materials



ORANGE: Communication lines or cables, including telephone, telegraph, cable TV, and traffic control lines



BLUE: Water lines



GREEN: Storm and sanitary sewers



PINK: Temporary survey markings



WHITE: (Optional): Proposed excavation area (by excavator).

Use of temporary markings

Use color-coded surface marks (i.e. paint or chalk) to indicate the location and route of buried lines. To increase visibility, color-coded vertical markers (i.e. stakes or flags) may supplement surface marks. Marks and markers may indicate the name, initials or logo of the company that owns or operates the line, and width of the facility if greater than 2 inches (50mm). Multiple lines in common trench may be marked in tandem. If the surface over the buried line is to be removed, supplementary offset markings are used. Offset markings are on a uniform alignment and clearly indicate the actual facility is a specific distance away.

Tolerance zones

Any excavation within a tolerance zone is performed with non-powered hand tools or a non-invasive method until the marked facility is exposed. The law specifies the width of the tolerance zone. The tolerance zone includes the width of the facility plus at least 18 inches (450mm) measured horizontally from each side of the facility.

**This page
intentionally
left blank**

Chapter 2

Erosion Control BMPs

Check Dam

Definition

A small, temporary dam constructed across a swale or drainage ditch.

Purpose

Check dams are used to slow the velocity of water thus reducing erosion of the drainage way. Although a check dam will trap small amounts of sediment, it should not be considered as a sediment control device.

Limitations

- Maximum drainage area is 10 acres.
- Do not use straw bales. The use of straw bales as check dams often involves incorrect placement and thus aggravates erosion problems rather than controlling them.
- Do not use in a stream.

Installation

- Check dams should be constructed of stone or logs. Currently straw bales are most often used and often cause problems. It is recommended that the straw would be put to better use if it were spread out to mulch the swale. Silt fence material may be used for check dams. *Note: if using silt fence material be aware that the runoff will flow over not through the material. Ensure that the fabric height is set no higher than 18 inches, the center is lower than the ends, that the bottom of the fabric is trenched in and soil compacted and that splash protection is provided on the downhill side so that the water running over the center doesn't scour the soil and expose the bottom of the fabric.*
- Make the check dam no more than 2 feet in height.
- Make the center of the check dam at least 6 inches lower than the outer edges.
- Cover the swale with the check dam and set the height of the outer edges so that runoff will not flow around either end.

- Space the check dams so that the center of each check dam is the same elevation as the bottom of the check dam immediately above it.
- If using logs, use 4-6 inch logs and drive them 18 inches deep. Pile brush on downstream side in order to prevent scouring.
- If using stone, use 3 to 6 inch stone placed on filter fabric.
- If using a prefabricated device such as Triangular Silt Dikes, then follow manufactures guidelines for installation. Spacing between check dams, however, is the same for all types. *Note: the use of a product name does not constitute an endorsement of the product, it is placed here to make the contractor aware that prefabricated devices exist. The contractor is responsible for verifying product claims and ensuring that a product will meet his needs.*

Maintenance

- Check for sediment accumulation after each significant rainfall. Remove accumulated sediment when it reaches ½ of the dam's original height.
- Check for erosion around edges of dam and extend dam if erosion is taking place.
- Remove dam when surrounding area has been stabilized. Immediately stabilize area under dam.

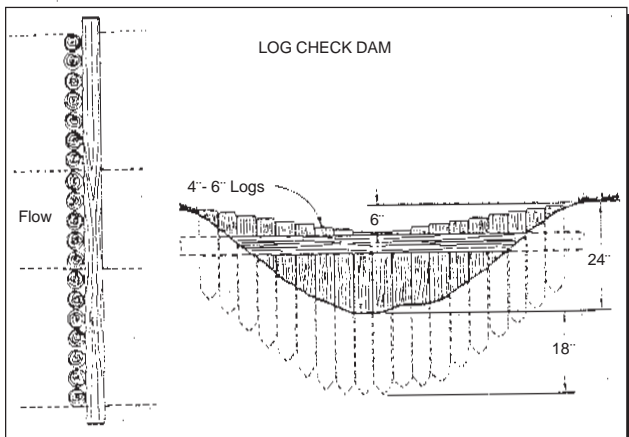

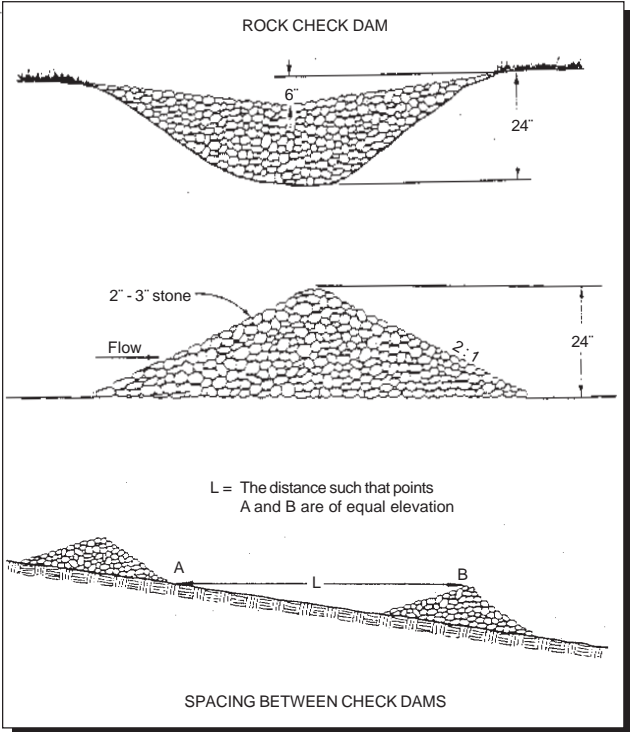

Source: Mississippi's Planning and Design Manual for Control of Erosion, Sediment and Stormwater.

Construction Road Stabilization

Definition

The temporary stabilization of construction access roads and parking areas.

Purpose

Reduce erosion of temporary and permanent roadbeds between the time of initial clearing and grading and final stabilization.

Limitations

None

Installation

- Follow the existing contour as much as possible. Slopes should not exceed 10 percent.
- Plan for temporary parking on naturally flat areas.
- Stabilize the side slopes of all cuts and fills by grading all slopes to 2:1 or flatter for clay soils and 3:1 or flatter for sandy soils. All exposed slopes should be seeded and/or mulched as soon as possible (see Construction Entrance, Stream Crossing, Temporary Seeding, Soil Blankets, and Dust Control).
- Lay down a 6-inch deep bed of coarse aggregate (1.5-3.5 inch stone) immediately after grading. Apply a tackifier or binder (see Dust Control).
- Ensure that proper drainage is provided for and that all drainage along construction roads is directed to sediment control BMPs (temporary sediment basins, buffer zones, sediment barriers, etc.).

Maintenance

- Top dress roads and parking areas as needed.
- Check drainage after rain events and ensure drainage is going to sediment control BMPs. Any bypasses shall be stopped and redirected to proper BMPs.

**This page
intentionally
left blank**

Construction Sequence

Definition

The coordination of the construction schedule with the necessary erosion, sediment, and stormwater BMP installation.

Purpose

- Minimize the amount of disturbed area, thus reducing erosion potential.
- Reduce erosion and off-site sedimentation by installing practices in a timely manner.
- Control erosion cost effectively by clearing only the area to be worked, instead of clearing the entire site at one time.

Limitations

- Requires planning and good communication between all parties involved.
- Differs from standard industry practice which calls for entire site to be cleared at one time. Instead, large sites would be cleared in stages with prior stages stabilized before next stage is disturbed.

Considerations

- List all land disturbing activities necessary to complete the proposed project in chronological order. Then list all practices needed to control erosion and sedimentation on the site. Combine the two lists in a logical order.
- Ensure that any disturbed areas that are not permanently stabilized, and are not scheduled for any activity to take place for 30 days or more, are seeded (see Temporary Seeding) within 7 days of the disturbance. The state permit for construction sites require vegetative practices to be installed within 7 calendar days of the land disturbing activity.
- The following table summarizes general scheduling considerations.

Construction Activity	Schedule Consideration
Construction access. Construction entrance, construction routes, equipment parking areas.	First land-disturbing activity—stabilize bare areas immediately with gravel and temporary vegetation as construction takes place.
Sediment traps and barriers. Sediment basins, sediment traps and sediment fences.	Install principal basins after construction site is accessed. Install additional traps and barriers as needed during grading.
Runoff control. Diversions, water bars, and outlet protection.	Install key practices after principal sediment traps and before land grading. Install additional runoff-control measures during grading. Install downslope and perimeter controls before major land disturbing activities.
Runoff conveyance system. Stabilize streambanks, storm drains, channels, inlet and outlet protection, slope drains.	Where necessary, stabilize streambanks as early as possible. Install principal runoff conveyance with runoff-control measures. Install remainder of system after grading.
Land clearing and grading. Site preparation, cutting, filling and grading, sediment basins, barriers, diversions, drains, surface roughening.	Begin major clearing and grading after principal sediment and key runoff-control measures are installed. Clear borrow and disposal areas only as needed. Install additional control measures as grading progresses. Mark trees and buffer areas for preservation. Don't allow equipment or personnel within dripline of marked trees.
Surface stabilization. Temporary and permanent seeding, mulching, sodding, riprap.	Apply temporary or permanent stabilization measures immediately on all disturbed areas where work is delayed or complete.
Building construction. Buildings, utilities, paving.	Install necessary erosion and sedimentation control practices as work takes place.
Landscaping and final stabilization. Topsoiling, trees and shrubs, permanent seeding, mulching, sodding, riprap.	Last construction phase—stabilize all open areas, including borrow and spoil areas. Remove and stabilize all temporary control measures.

A preconstruction conference is one of the most valuable vehicles by which you can address and divert many potential erosion and sedimentation problems before they become catastrophes. This conference provides an opportunity for you to meet face-to-face with the responsible party and the contractor. In this way, you can establish the expectations for the project and start a good working relationship with the job superintendent.

Begin land clearing and grading as soon as key erosion and sediment control measures are in place. Once a scheduled development area is cleared, grading should follow immediately so that protective ground cover can be reestablished quickly. Do not leave any area bare and exposed for

**This page
intentionally
left blank**

extended periods. Leave adjoining areas planned for development, or to be used for borrow and disposal, undisturbed as long as possible to serve as natural buffer zones.

Runoff control is essential during the grading operation. Diversions, slope drains, and outlet protection installed in a timely manner can be very effective in controlling erosion during this critical period of development.

Apply surface stabilization on graded areas, channels, dikes, and other disturbed areas immediately after land clearing and grading. Stabilize any disturbed area where active construction will not take place for 30 working days by temporary seeding and/or mulching or by other suitable means. Install permanent stabilization measures immediately after final grading, in accordance with the vegetative plan. Temporary seeding and/or mulching may be necessary during extreme weather conditions with permanent measures delayed for a more suitable time.

Coordinate building construction with other development activities so that all work can take place in an orderly manner and on schedule. Experience shows that careful project scheduling improves efficiency, reduces cost, and lowers the potential for erosion and sedimentation problems.

Landscaping and final stabilization is the last major construction phase, but the topsoil stockpiling, tree preservation, undisturbed buffer area, and well planned road locations established earlier in the project may make this activity easier. All disturbed areas should have permanent stabilization practices applied. Unstable sediment should be removed from sediment basins and traps. All temporary structures should be removed after the area above has been properly stabilized. Borrow and disposal areas should be permanently vegetated or otherwise stabilized.

Diversion

Definition

A temporary ridge and channel of compacted soil.

Purpose

Used to divert runoff coming from offsite areas adjacent to the construction site or divert runoff from sensitive areas, thus decreasing the erosion potential. A diversion can also be used on a construction site to carry sediment-laden runoff to a sediment trap.

Limitations

- Maximum drainage area is 5 acres.
- Diversions placed at the bottom of very steep slopes may be overwhelmed (overtopped or washed out from flows coming down the slope).
- Diversions must be on proper grade to ensure water flows in the desired direction. Watch for abrupt changes or reversal of grade as failures will occur in these places.
- Ensure that equipment operators are informed about diversions. A common reason for failure of diversions is equipment being driven over the diversion.

Installation

- Minimum height of ridge (measured from bottom of channel to top of ridge) is 18 inches.
- Make the top width of the ridge a minimum of 2 feet with 3:1 slopes.
- Determine path of channel, ensuring that channel has a positive grade and ends at a stabilized outlet (see Level Spreader, Slope Drain or Temporary Sediment Basin for example).
- Excavate channel, place dirt on downslope side, shape to specified dimensions and compact.
- If diversion will be in place for more than 30 days, then seed after ridge has been shaped and before compaction.
- On fill slopes, form channel at end of working day and do not compact until final grade is reached.

Maintenance

- Inspect after every storm and repair any breaches.

- If channel continues to erode, then velocities are too high and channel must be stabilized with erosion control netting or other stabilization practices.
- If diversion is at foot of steep slope and breaches continue to occur after successive storm events, then move diversion away from slope (if possible) and stabilize slope with mulch (see Soil Blankets).

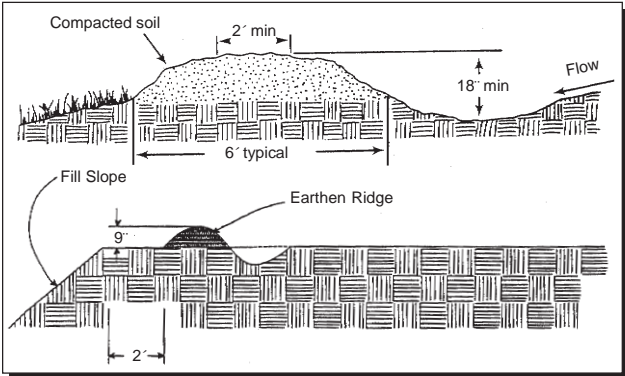

Source: Florida Erosion and Sediment Control Inspector's Manual

Level Spreader

Definition

A stable outlet for diversions, which collects runoff and discharges it as sheet flow onto an undisturbed, vegetated area.

Purpose

To collect concentrated runoff, convert it to sheet flow and release it to a stable area at low, non-erosive velocities.

Limitations

- Runoff should be relatively sediment free.
- Drainage area is 5 acres or less.

Installation

- Construct on undisturbed soil (not fill).
- Set last 20 feet of diversion slope to 1% grade before flow enters level spreader.
- Size the level spreader at zero grade.
- Slope sides at 2:1 or flatter.
- Seed the level spreader with grass seed or sod within 7 days of construction.

Maintenance

- Inspect after each storm event to ensure that flow is not concentrating and causing erosion at outlet. Repair if necessary.
- Remove any leaves and debris.
- Prevent construction traffic across the structure.

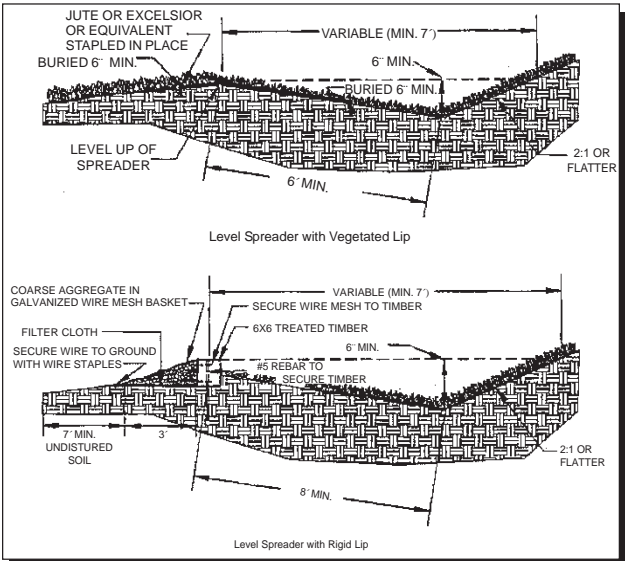
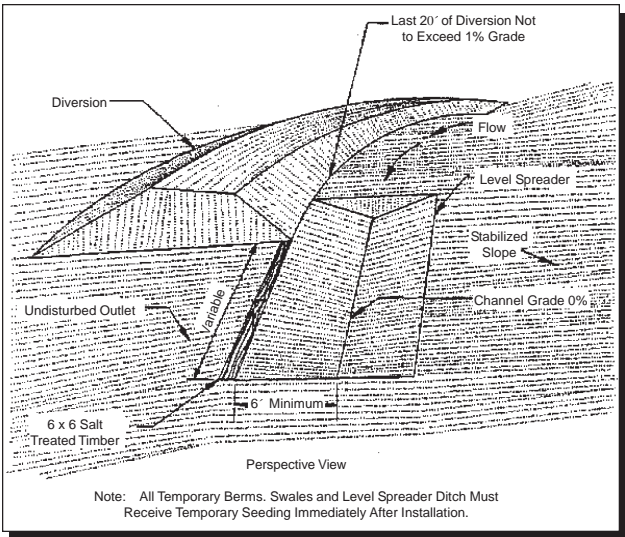

Source: Florida Erosion and Sediment Control Inspector's Manual

Permanent Seeding

Definition

Establishing a permanent vegetative cover using perennial seed on disturbed areas.

Purpose

To reduce or eliminate erosion on disturbed areas that have been brought to final grade.

Limitations

- Seed may be washed away during establishment phase.
- Establishment phase may take from 7 to 21 days.
- Good germination is dependant on soil and weather conditions.
- Seasonal limitations.
- Different areas and soil types require different plantings (consult a landscape specialist, local nursery, local soil and water conservation district or county agent).

Installation

- Remember that most subsoils are not capable of supporting dense growth so minimize area of disturbance and stockpile topsoil.
- Do a thorough soil sampling to determine lime and fertilizer needs. Do this well in advance of planting as test-results can take up to six weeks to obtain.
- Do not till when soil is wet.
- Prepare site by tilling to loosen soil. Till across slopes rather than up and down the slopes (note that this is a different direction than what is recommended for a bulldozer as the disks or plow points are in line with the direction of travel. In either case the result is the same - the creation of small ridges that are perpendicular to the slope, thus slowing runoff and trapping sediment).

- Incorporate lime and fertilizer while tilling.
- Incorporate organic amendments while tilling. Use these amendments when topsoil is unavailable, drains too quickly to support plant growth, or consists of heavy clay.
- Roughen surface immediately prior to spreading seed. Spread seed before rain seals the surface. Be sure to groove or track slopes (see Slope Surface Roughening). Cut grooves so that they run across slopes rather than up and down. This will create a terrace effect.
- Spread seed uniformly.
- Lightly rake soil after seeding to ensure good seed to soil contact.
- Spread mulch, especially on slopes and poor soils (see Mulching for further information).
- Water as needed.
- Hydroseeding is a good way to obtain fast establishment. This requires the use of specialized equipment and a contractor knowledgeable in hydroseeding.

Maintenance

- Inspect regularly until vegetation stand is well established.
- Remember that a stand is not fully established until it has been maintained 1 year.
- If rills and gullies develop, fill, reseed and mulch as soon as possible.
- If rills and gullies continue to form in same area, use sod or erosion control netting.
- If stand has less than 50% cover, re-evaluate vegetation choice and soil type/requirements.

Pollution Source Controls

Definition

Minimizing nonpoint source (NPS) pollution from construction sites through good housekeeping.

Purpose

To reduce the amount of construction-related pollutants that may be carried off site by runoff.

Limitations

Dependent upon knowledge and willingness of contractor to take proper steps.

Considerations

- Development and implementation of a good erosion and sediment control (E&SC) plan will help control other NPS pollutants.
- Create an area for maintenance and repair of construction machinery. Protect the area from rain, if possible, and prevent runoff. Locate and design the area so that oils, fuels, grease, solvents, and other pollutants can't be washed into streams, stormwater conveyance systems, or other water bodies.
- Create a plan for adequate collection and disposal of waste materials. Cover trashcans and dumpsters to prevent rain water from entering. Keep trash and rubbish disposal sites away from all concentrated stormwater runoff (drainage ditches, natural drains, and stormdrains).
- Store all chemicals, cements, solvents, paints, or any other potential pollutants in a covered location unaffected by runoff. Never wash any container in or near a stream or a stormdrain. Prevent leaching into the soil in order to protect groundwater.

**This page
intentionally
left blank**

Soil Blanket (Mulch, Mats, Binders)

Definition

Applying a protective blanket (usually plant residue) to bare soil.

Purpose

Protects soil from the force of rain. Protects seeds and soil amendments from being washed away. Aids vegetative growth by conserving moisture, suppressing weeds and insulating the soil and seed from temperature extremes.

Limitations

- Mulches can be a source and method of introducing weeds.
- Too much mulch can suppress growth.
- Wood chip mulches can tie up nitrogen thus requiring additional fertilizer.
- Some erosion control blankets degrade after a time and some blankets are permanent. Make sure the correct one is specified for the job.

Installation

Installation method varies for the type of mulch used and should be outlined in job specifications.

1. Mulch

- The most common mulch is straw. When spreading by hand, divide the area to be mulched into 1000 square foot blocks and spread 2 square bales per block. When using equipment to spread mulch over larger areas use 2 tons per acre. When applying mulch to slopes equal to or steeper than 3:1, slopes with runs longer than 50 feet, areas of concentrated flow and in large open areas where wind is not blocked, mulch shall be anchored. Other mulch materials such as wood cellulose fibers, composted vegetation, recycled materials for mulch, and hay are acceptable. Apply enough material to obtain good coverage.
- Anchor straw or hay mulch by crimping, by overlaying with an erosion control blanket, or by using a tackifier.

All other mulches should be anchored with an erosion control blanket or a tackifier.

- When crimping use a mulch crimper (packer disc) or equivalent anchoring tool. The crimper should have discs that can be set straight, are 20 inches or more in diameter, 8 to 12 inches spacing between discs, and the disc edges are dull enough to press the stalks into the ground without cutting them. Ensure that the mulch stalks (or fibers) are pushed into the soil approximately 3 inches.
- For any mulch material used, ensure that good coverage is obtained. Good coverage is where the mulch completely covers bare soil but is no more than 1 – 2 inches thick.

2. Erosion Control Blankets

- This type of product is known by several different names: erosion control blankets, erosion control matting, erosion control nets, rolled erosion control products, and turf reinforcement materials.
- Some of these blankets are photodegradable, some are biodegradable, some are permanent and some have seeds and mulch embedded in the matting. Ensure that the right one is used for the job. Consider the use of the area after construction, whether mowing will be done or if this will be an area that carries concentrated, high velocity flows. This will affect the selection decision. For areas that will be mowed, use temporary erosion control netting that has a maximum serviceable life of 3 months or use soil binders.
- Nets shall be used to anchor organic mulches on steep slopes and areas with concentrated flows.
- When used with seeding, prepare soil and place seed according to directions in temporary or permanent seeding. Ensure that soil surface is free of rocks, roots or other debris.
- Spread organic mulch.

- Lay down netting on top of organic mulch ensuring firm, continuous contact with soil and anchor according to specifications. Further information can be found through the Erosion Control Technology Council website at www.ectc.org.

- **Guide for installing on slopes**

- On slopes netting shall be laid parallel to slope (parallel to primary direction of flow).
- Dig a 6-inch by 6-inch trench at the top of the slope. Unroll 4 feet of the netting, line trench with netting while leaving 3 feet of netting extended past the trench.
- Anchor netting in trench with staples, backfill and tamp soil firmly. Take remaining 3 foot strip that is extended past the trench and fold over the trench. Fasten strip to netting with staples. Unroll netting down the slope.
- Start at top of slope or grade, anchor net, and work down.
- Where strips are laid side by side, overlap edges 3 inches and staple together.
- When joining ends, anchor new net in trench, overlap with old net 18 inches and staple together below trench.

- **Guide for installing in channels**

- In areas of concentrated flows (ditches, swales, storm water conveyance channels, etc.) lay netting in direction parallel to flow. Use turf reinforcement mats for greater strength.
- Dig a 6-inch by 6-inch across the beginning of the channel (upstream end) where netting will be laid.
- Anchor and unroll netting as described above.
- Do not join strips of netting in the center area of concentrated flows.

3. Soil Binders

- If using manufactured mulches such as erosion control netting, straw blankets, wood fiber blankets, wood fiber mulch with tackifier, bonded-fiber matrix, etc., refer to manufacturer's recommendation.

Maintenance

- Inspect periodically and after rainstorms.
- Check for rills, dislocation, or failures, and repair.
- If washout occurs, then regrade, reseed and remulch.
- If washout continues, check to see if flow velocities or if contributing area are too great and install additional measures to slow velocities and/or divert a portion of the flow.

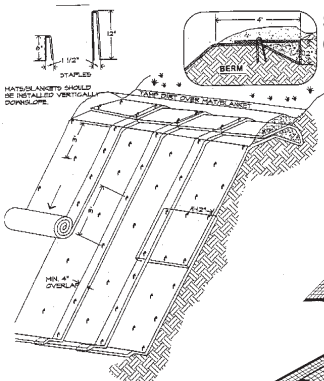

Installation of netting on slopes

Source: Florida Erosion and Sediment Control Inspector's Manual

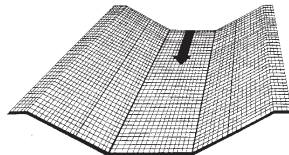

In channels, roll out strips of netting parallel to the direction of flow and over the protective mulch.

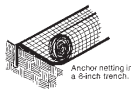

Anchor netting in a 6-inch trench.



18° overlap Join strips by anchoring and overlapping.

Installation of netting and matting.

Source: Mississippi's Planning and Design Manual for Control of Erosion, Sediment and Stormwater.

Temporary Seeding

Definitions

Establishing a temporary vegetative cover on disturbed sites by seeding with a fast growing annual grass.

Purpose

To stabilize disturbed areas that will not be worked on within 30 days. Temporary seeding reduces erosion, thus reducing the need for more costly sediment control measures.

Limitations

- Temporary seeding provides protection for only one growing season. After that time, more permanent measures should be initiated.
- Seed is subject to being washed away during establishment period.
- Be aware that certain annual grasses may still out-compete permanent seeding even after the end of their life expectancy. This will require the residue from the annuals to be disked up and the soil prepared for permanent seeding.

Installation

- Loosen all soil that has been compacted, crusted, or hardened.
- Test soil to determine liming and fertilization requirements. In the absence of a soil test, apply according to local soil conservation district's or a local nursery's direction.
- Spread available topsoil over unfavorable soil conditions, especially exposed subsoil.
- On slopes, the surface will require roughening, mulching, or both, depending on grade (see Mulching and Surface Roughening).
- Apply seed uniformly.
- Plant grass seed 1/4 inch deep (normal depth).
- Water as needed.

Maintenance

- Inspect for germination and growth after 7 days from planting.
- If seed is not germinating or growth is sparse, perform soil test, fertilize and reseed according to directions.
- Inspect after rainstorms. Reseed wherever seed has been washed away. Consider the use of erosion control netting, mulch, or other BMPs in areas where seed continues to be washed away and channels are forming.

General Recommendations for Temporary Seeding in Mississippi

SPECIES	SEEDING RATE / AC	PLANTING TIME	DESIRED PH RANGE	FERTILIZATION RATE / AC	METHOD OF ESTABLISHING
Wheat	90 lbs	Sept 1 – Nov 30	6.0 – 7.0	600 lbs 13-13-13	seed
Ryegrass	30 lbs	Sept 1 – Nov 30	6.0 – 7.0	600 lbs 13-13-13	seed
White Clover	5 lbs	Sept 1 – Nov 30	6.0 – 7.0	400 lbs 6-24-24	seed
Crimson Clover	15 lbs	Sept 1 – Nov 30	6.0 – 7.0	400 lbs 6-24-24	seed
Hairy Vetch	30 lbs	Sept 1 – Nov 30	6.0 – 7.0	400 lbs 6-24-24	seed
Browntop Millet	40 lbs	April 1 – August 30	6.0 – 7.0	600 lbs 13-13-13	seed

Vegetative Establishment Calendar

<u>Mar</u>	<u>Apr</u>	<u>May</u>	<u>June</u>	<u>July</u>	<u>Aug</u>	<u>Sep</u>	<u>Oct</u>	<u>Nov</u>	<u>Dec</u>	<u>Jan</u>	<u>Feb</u>
----- 1 -----			----- 2 -----			----- 3 -----			----- 4 -----		

1) Warm Season Covers:

Bermuda
Bahia
Centipede
Weeping Love Grass

3) Cool Season Cover:

Wheat
Ryegrass
Clover
Hairy Vetch

2) Temporary Summer Cover:

Browntop Millet

4) Mulch Cover Only

Topsoiling

Definition

Salvaging, storing and reusing topsoil that has been removed during clearing and grading.

Purpose

To provide a good growth medium for the reestablishment of vegetation after final grading.

Limitations

- Can introduce noxious weeds.
- Soil characteristics may not be suitable for vegetation that is desired and thus require the added expense of soil amendments.
- Should not be used on slopes greater than 2:1 particularly if it is sandy topsoil over clay subsoil.

Installation

- Conduct a field evaluation of site to determine if there is sufficient topsoil of good enough quality to allow for this BMP to be used. Topsoil should be friable, loamy, relatively free of debris and noxious weeds, and show that it can support healthy plant growth.
- If topsoiling will be used, then strip topsoil. A stripping depth of 4-6 inches is commonly used.
- Stockpile topsoil near where it will be spread, but out of the way of work traffic.
- Do not stockpile in drainageways or on slopes.
- Install perimeter sediment control measures around stockpiles.
- Shape side slopes of stockpiles to 2:1.
- If stockpile will not be used within 30 days, then apply temporary seeding immediately or other stockpile protection measures immediately.
- Before applying topsoil, check to see if subsoil needs any soil amendments and apply.
- Scarify or disc subsoil to a 2-inch depth to achieve a good bond with topsoil.
- Spread topsoil uniformly.

- Add seed and any necessary soil amendments.

Maintenance

- Inspect periodically and after rainstorms.
- Inspect for seed germination, formation of water pockets, and for erosion.
- If erosion is taking place or water pockets have formed, re-grade and re-seed.
- If good seed germination isn't taking place, and/or good vegetative cover doesn't exist, take steps outlined in maintenance section of permanent seeding.
- If erosion continues to take place, then check velocity and amount of drainage across site and install additional measures to slow water and/or redirect some of the flow.

Tree Preservation

Definition

Protecting desirable trees from destruction or injury during clearing or other construction activities.

Purpose

To ensure the survival of desirable, existing trees during construction so that they can provide erosion control, stormwater runoff management, improved site aesthetics, and other environmental benefits.

Limitations

- Consideration must be given to selecting trees to be protected so that preservation efforts aren't wasted on a tree that has little chance of survival.
- A qualified professional should be consulted to determine which trees to save.

Installation

- Select trees to be preserved before disturbing land and flag them.
- Mark trees to be saved on erosion and sediment control plan and on site where clearing and grading will take place.
- Install barrier at or outside the dripline (see illustration).
- Do not use heavy equipment, vehicles, or stockpiles within the dripline.
- Do not store any toxic materials within 100 feet of trees to be preserved.
- Ensure that crew, especially operators of earth-moving equipment, know where the trees are and what the purpose of the fencing is.
- Do not trench through the dripline. Tunnel or reroute utilities.
- Do not nail anything to trees to be preserved.

Maintenance

Note: *If roots are cut, then prune tree by a proportionate amount (example, if 1/3 of the roots are cut, then prune tree by 1/3). Remove any damaged root area and paint the pruned area with tree paint.*

- Repair any damage to trunk by trimming around damaged area (tapering the cut), and paint with tree paint.
- Cut off any damaged branches with a three cut process, and paint with tree paint.

Correct Methods of Tree Fencing

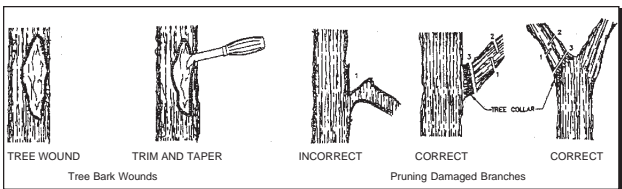
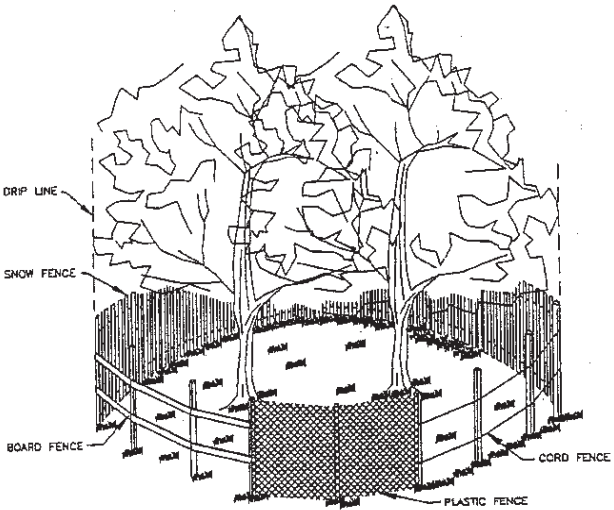

Source: Florida Erosion and Sediment Control Inspector's Manual

**This page
intentionally
left blank**

Chapter 3

Sediment Control BMPs

Buffer Zone

Definition

A vegetated strip of land bordering a stream, or surrounding a development.

Purpose

To provide a filter for runoff, protect streambanks from erosion, and provide necessary shade in order to protect streams from extreme temperature fluctuations. To provide a dust/sound/visible appearance barrier around a construction site.

Limitations

None

Installation

- Mark buffer zone clearly. Buffer zone should have a minimum width of 50 feet (marked from top of bank) along both sides of intermittent streams, 150 feet from perennial streams (marked as blue line on quad map), and 300 feet from navigable waterways. Increase width if stream is on state's list of impaired waters, or for steep slopes or highly erodible soils. For visible appearance barriers around construction sites set the minimum width of the buffer zone at 30 feet.
- Ensure that the entire construction crew is made aware of buffer zone and that it is to be left undisturbed.
- Where crossing must be done, ensure that crossing width is kept to minimum and install necessary BMPs to prevent erosion or control sediment (see Stream Crossing).

Maintenance

- Ensure that any channels conveying runoff through buffer zone are either blocked or protected by BMPs.
- Inspect after storm events. Look for sediment trails through buffer zone. If channel is forming, or sediment trails go through the buffer, construct diversions and level spreaders next to buffer zone, or install other appropriate BMPs.

**This page
intentionally
left blank**

Construction Entrance

Definition

A stabilized pad located at the entrance/exit point of a construction site.

Purpose

To stabilize the entrance and reduce the amount of sediment being tracked or washed onto public roads.

Limitations

- If gravel pad is insufficient to remove dirt from tires, then tires must be washed before vehicle leaves site. This is particularly true for sites with heavy clay soils.
- Public roads must be swept as required to keep them free of sediment and stone.

Installation

- Excavate a pad that is at least 50 feet long, extends the full width of the construction road and is 6 inches deep.
- Lay down filter fabric.
- Backfill with coarse gravel (1.5 to 3 inch stone). Use stone that is large enough to not get picked up in the grooves of truck tires.
- Widen pad at connection with road to provide for turning radius of trucks.
- Use in conjunction with Construction Road Stabilization.
- Coarse wood chips that won't float away may be used at the entrance to a single family residence construction site.

Maintenance

- Sweep paved road daily to remove dirt and stones.
- Redress stone as conditions demand (do not let filter fabric be exposed).
- Washout accumulated sediment so that stone remains exposed and has void spaces for sediment. Ensure that wash water runs to a sediment trap.

Construction Entrance

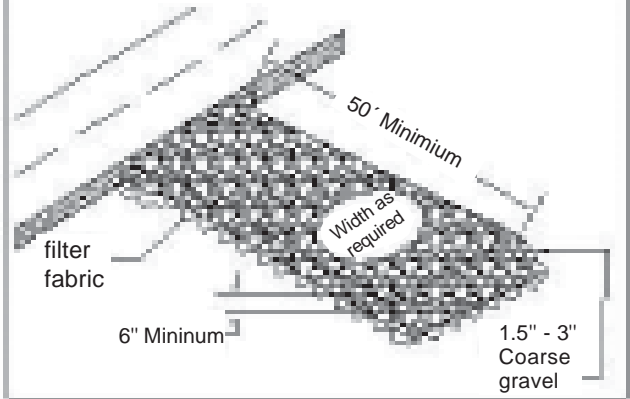

CONSTRUCTION ENTRANCE WITH WASH RACK

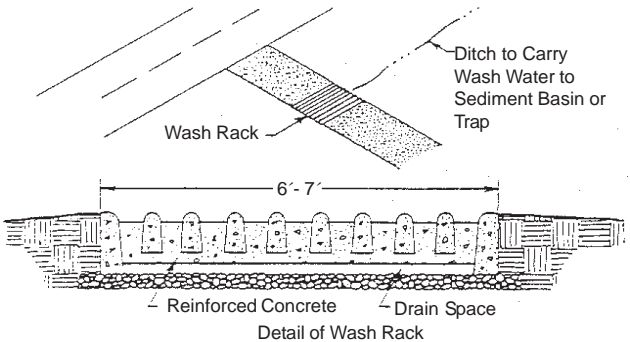

Source: Mississippi's Planning and Design Manual for Control of Erosion, Sediment and Stormwater.

Dust Control

Definition

Controlling dust while land-disturbing activities are taking place.

Purpose

To prevent the movement of dust from exposed surfaces, thus preventing or reducing complaints about air quality, health hazards, and reducing vehicle and road maintenance.

Limitations

- Calcium chloride can be mildly corrosive.
- Ligninsulfonates work best in dry climates and are not recommended for Mississippi.
- Be aware of curing times and keep traffic off of sprayed-on surfaces until cured.
- Dampening down with water only works for a very short time. It is recommended that additives be used.

Installation

- Installation is dependent on the type of control one is using. Follow manufacturer's recommendations.
 - When applying dust suppressants to road surfaces, ensure that the road surface is graded and gravel with fines have been laid down (see Construction Road Stabilization).
1. Chloride-based (calcium chloride or magnesium chloride)
 - Wet down surface as chloride-based suppressants requires water.
 - If applying as dry flakes then mix into top 2 -4 inches of roadbed material and compact with a roller.
 - If applying as a liquid then spray on roadbed according to manufacturer's recommendation.

2. Resins

- General resin application will be a resin-in-water emulsion with 4 parts water to 1 part resin, spray as a fine spray, and apply at a rate of 300 gallons to the acre.
- Follow specific manufacturer's recommendations if different from above.

3. Polymers

- Follow manufacturer's recommendations.

Maintenance

- Prohibit traffic on treated surface until curing time is complete.
- Supplement or reapply surface covering as needed.

Floating Turbidity Barrier

Definition

A floating barrier to trap suspended sediment.

Purpose

To provide sediment protection for a waterbody from adjacent land disturbance when conventional BMPs can't stop sediment from entering the waterbody, or to trap sediment generated from work within a waterbody.

Limitations

- Turbidity barriers are not designed to impound water and should not be used as a dam.
- Do not install a turbidity barrier completely across a channel.

Installation

Note: More complete installation instructions should be obtained from a qualified engineer and/or the product manufacturer. This section was written so that the reader will be aware that this product exists and should be used for the purpose shown. The installation procedures outlined are to provide general guidance only.

- There are three main types of turbidity barriers. Type 1 is for use in waters where there is no current and little wind or wave action expected. Type 2 is for use in waters with moderate currents (up to 3.5 feet per second) and where moderate wind or wave action can be expected. Type 3 is for waters where currents are 3.5 to 5 feet per second, where tides are present and/or where wind and wave action is more pronounced.
- Type 1 and 2 should extend to the bottom to prevent sediment-laden water from escaping.
- Type 3, and Type 2 in constant wind/wave exposure, should extend no more than 12 feet below the surface. Set a minimum 1-foot gap between the bottom of the barrier and the channel bottom at low flow. This is to prevent "fanning" of the bottom which will stir up more sediment.

- Extend the ends well up onto the shoreline and anchor securely.
- Place curtain so that it is parallel to the direction of flow.
- Set a minimum span of 50 feet between joints (rule of thumb).
- Set anchor points at a maximum of 100 feet apart.
- Use bright material for barriers located in boating areas.
- In calm water, set the anchor points, then tow the curtain along (in the furled condition) and attach to anchor points.
- Set any additional anchor points needed to maintain desired location and attach to curtain. Anchor lines are attached to bottom edge for Type 1 curtains.
- Cut furling lines to let curtain skirt drop into position.
- For Type 2 and 3 installation, set all anchor points and anchor buoys. For tidal action, anchors must be set on both sides of the barrier to hold in place.
- Attach furled curtain to upstream anchor point first and then attach sequentially to each next downstream anchor point. Attach anchor lines to flotation devices on top of curtain.
- Adjust location, if necessary.
- Cut furling lines.

Maintenance

Follow manufacturer's recommendations for maintenance and removal.

**This page
intentionally
left blank**

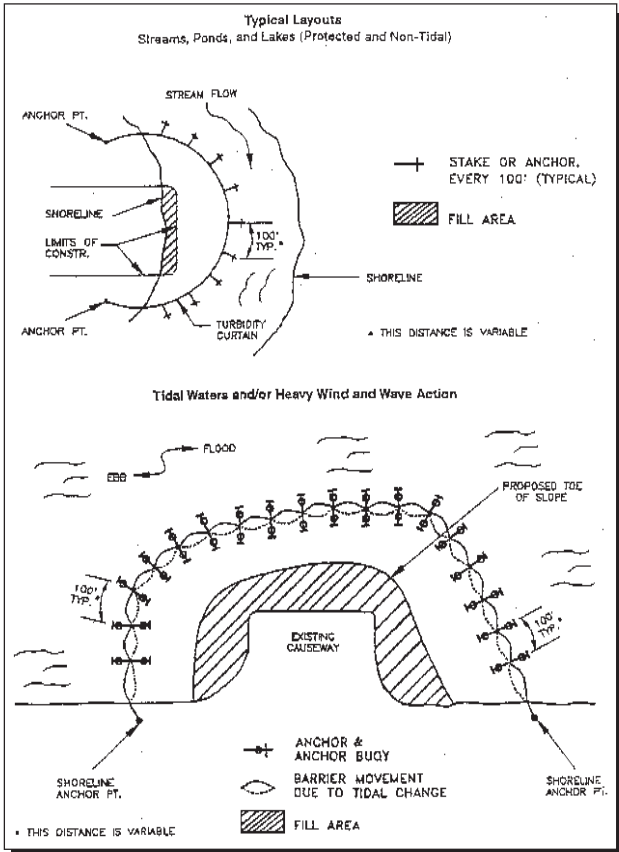

Source: Florida Erosion and Sediment Control Inspector's Manual

Sediment Barrier

Definition

A temporary barrier to moving sediment, works by ponding water thus slowing velocity and allowing soil to settle out.

Purpose

To trap sediment in sediment-laden runoff and prevent it from being carried off-site.

Limitations

- Do not use in ditches or streams.
- Improper placement and installation can cause more erosion problems.
- Their effective life is only a few months depending on the type of barrier used as well as rainfall frequency and severity.
- Sediment barriers **must** be used in conjunction with erosion controls or they can be quickly overwhelmed.
- Do not install below outlet pipes, weirs or any place where concentrated flows occur.

Installation

Note: There are several different products that can be used as sediment barriers. Naming a specific product does not constitute an endorsement of the product. These are listed in order to make the contractor aware of the different sediment barriers available.

1. Silt fence

- The bottom 8 - 12 inches of fabric must be dug into the ground. This can be done either by slicing (recommended method), trenching with a trencher, or dug by hand.
- When using a slicing machine the silt fence fabric will be inserted into the ground automatically as the machine digs a narrow trench. If using another trenching method then lay the bottom 8 – 12 inches of fabric into the trench. Bury the first 12 to 24 inches of fabric and press down the soil in order to hold the fabric. Pull the fabric tight (you will need to do this in stages going around curves) and backfill the trench. Ensure that backfill is free of vegetation and debris. Ensure that the fabric is stretched tight along its length.

- Whatever method is used to insert the fabric into the trench, the soil around the fabric must then be compacted. Compact using the wheel of a tractor, roller or other machine that exerts a compacting force of 60 pounds per square inch or greater. Compact the uphill side first then flip the fabric over and compact the downhill side. Use a minimum number of 2 passes per side.
- Use steel fence posts (recommended) or wooden posts (4-inch diameter or 2 x 2) that are a minimum of 5 feet in length. Install posts on 6-foot centers or less. Install posts on 4-foot centers around curves where runoff will be concentrating.
- Drive posts 24 inches into the ground on the downhill side of the fabric and as close as possible to the fabric. If using standard metal “T” posts, install so that post nipples are facing away from the fabric.
- Starting at one end, pick up fabric and attach to posts. Set fabric no higher than 18 to 24 inches high. Ensure that fabric is pulled tight both up on the post and along its length. Attach fabric to posts using 3 ties in the top 8 inches of the fabric. Put each tie on a diagonal, hanging on a post nipple, secure and tighten. Use plastic cable ties (50 pounds).
- Avoid long, continuous runs of silt fence, if possible. Install silt fence in a series of “J” or “U” hooks (refer to illustration). Make sure that the ends of the silt fence are turned far enough uphill so that all runoff will be directed to the center of the curve and not flow around the ends.
- Ensure that there is no more than 1/4 acre of drainage area per 100 feet of fence. Avoid continuous runs of silt fence that are longer than 200 feet. Do not allow more than a 2:1 (horizontal to vertical) slope gradient behind the fence and no more than 100 feet of slope length. Ensure that the silt fence is installed at least 6 feet away from the toe of the slope to allow for ponding.
- **Provide a safe outflow or pad at the center of the curve where runoff will overflow. Ensure that the center of the curve is slightly lower than the rest of the fence so that runoff will overflow at the center.**

Maintenance

- Remove accumulated sediment along the fence when it has reached a third to a half of the fence height. Do not place sediment on the downhill side. Or construct a new fence immediately uphill or downhill from the existing fence.
- Inspect weekly and after each significant storm event (greater than ½ inch of rain).
- Remove fence when area above the fence has been stabilized.
- If fabric is torn, then replace with a new piece that stretches to posts on either side of the tear.

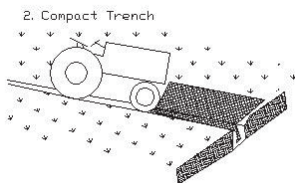
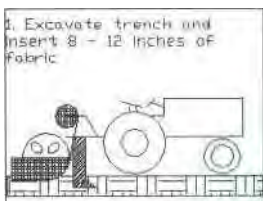

3. On downhill side of the trench, set fence posts on 6 foot centers.

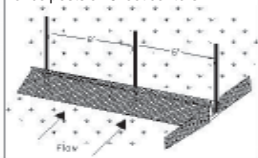

4. Tie fabric to post. Use 2 ties in the top 8 inches.

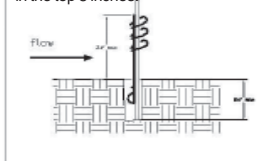

2. Fiber logs (also known as wattles)

- Fiber logs, or wattles, are rolls made of rice straw, or coconut fiber, which is placed inside plastic netting.
- These can be good for reducing slope length on steep slopes, for very low gradient sites that are small, or for preventing sediment from leaving small stockpiles.
- Scrape out a shallow depression along the line where the fiber log will be laid. Ensure that there are no roots, rocks, or lumps in the depression.
- Lay the fiber log in the depression.

- Stake down according to manufacturer's recommendation.
- If using to protect a stockpile on a hard surface where no digging can take place, then lay the fiber log on the surface ensuring that all ends are abutting tightly and fastened to each other. Use sandbags or concrete blocks on the outside to prevent movement.

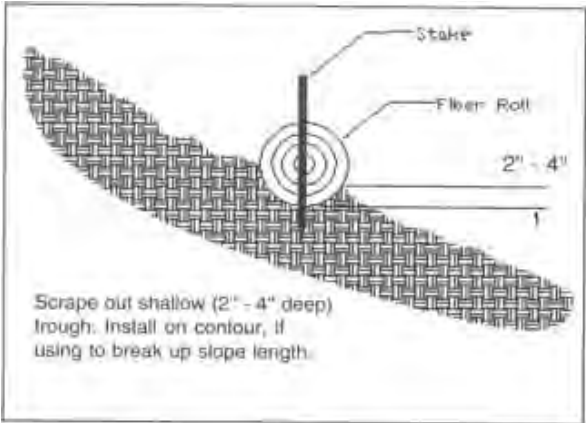

Sediment barrier placement to break up slope length

Slope (percent)	Max distance between barriers (feet)
<2	100
2 - 5	75
5 - 10	50
10 - 20	25
>20	15

3. Continuous berm machine

- This requires a specialized piece of equipment and someone trained in the operation of the machine.

4. Straw bales (not recommended for sediment barriers – see Mulch for recommended uses)

Stockpile Protection

Definition

A covering over, or a barrier around a stockpile.

Purpose

To keep the loose dirt of a stockpile from being washed away to a nearby stream, storm drain or public road.

Limitations

- Requires extra effort on part of the contractor or maintenance crew to remove barrier, or covering, every time stockpile must be accessed.

Installation

1. Plastic sheeting

- Cover stockpile with plastic sheeting (at least 4 mils thickness).
- Anchor plastic sheeting with sandbags laid in a grid pattern (no more than 10 foot by 10 foot grid).

2. Fiber roll

- If stockpile is placed on ground, then scrape a shallow trench around stockpile.
- Ensure trench is even and free of rocks, roots or debris.
- Lay fiber roll in trench.
- If using more than one fiber roll, ensure that ends are pushed tightly together.
- Drive manufacturer-provided stakes into fiber rolls, ensuring that a stake is driven in within 6 inches of each end and 4 foot spacing for all other stakes. Ensure that stakes are driven a minimum of 6 inches into the ground.
- If stockpile is placed on a hardened surface where no excavation can be done, then lay fiber roll(s) on surface.
- Ensure ends are pushed tightly together.
- Lay sandbags around outside of fiber roll(s) as anchors. Use a sandbag wherever ends are abutted together.

3. Silt fence

- Can use only when stockpile is placed on ground where a trench can be dug.
- See Sediment Barrier for installation instructions.

4. Temporary vegetative cover

- See Temporary Seeding or Soil Blanket

5. Temporary Sediment Trap

- Where stockpile will be accessed regularly (for example a County Road Barn) construct diversion to a sediment trap (see Temporary Sediment Trap).

Maintenance

- Inspect regularly and repair.

Storm Drain Inlet Protection

Definition

A filter or impounding area around a storm drain inlet.

Purpose

Prevent sediment from construction site from entering an existing storm drain system until disturbed area is permanently stabilized.

Limitations

- Drainage area to an individual drain shall be one acre or less.
- Ponding will likely occur so ensure that damage will not occur to adjacent areas or structures.
- May require frequent cleaning.
- Use mulch around structure to reduce the sediment load.

Installation

Note: Type of inlet protection used will depend on site conditions and type of inlet to be protected. The use of hay bales for protection is not recommended.

1. Silt fence drop inlet sediment filter

- Use where drop inlet is surrounded by relatively flat ground and sheet flows are expected. Excavate a shallow depression around the inlet to allow for some ponding.
- Construct a frame around the drop inlet using 2"x 4" stakes. Drive stakes into ground around drop inlet and no more than 3 feet apart. Drive stakes into the ground at least 12 inches. Attach a top rail of 2"x 4" to the stakes to stabilize the frame. Diagonally cross brace the stakes to prevent the water from pushing over the fabric. Ensure that water will fall directly into the inlet opening, not onto the unprotected soil around the inlet box.
- Excavate a trench 6" x 6" around the outside edge of the frame.
- Measure out filter fabric needed to ensure that fabric can be wrapped around frame with one overlap panel in order to ensure that there are no joints to separate.

- Staple fabric to frame with 12 inches lying in the trench. The height of the fabric shall be at least 15 inches above ground but no more than 18 inches high.
- Backfill trench and compact over fabric.

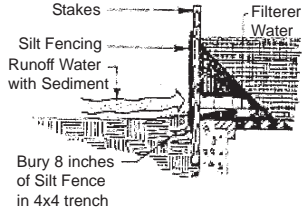
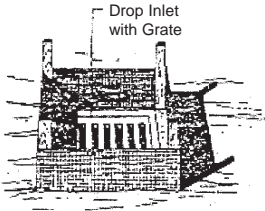

Source: Mississippi's Planning and Design Manual for Control of Erosion, Sediment and Stormwater.

2. Block and gravel drop inlet protection

- Use this where excavation cannot be done (i.e. to protect a storm drain in pavement) and/or where heavier concentrated flows are expected. Do not use where ponding will damage adjacent area or structures. Ensure that approaches are fairly flat to allow temporary ponding.
- Place concrete blocks on their side, lengthwise around the inlet. Place blocks so that all ends are abutting. Height can be varied by stacking blocks but should be between 12 and 24 inches in height. Cover outside face of blocks with wire mesh.
- Pile coarse aggregate (3/4 – 1.5”) against wire mesh.

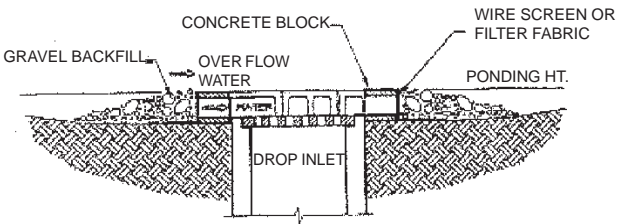
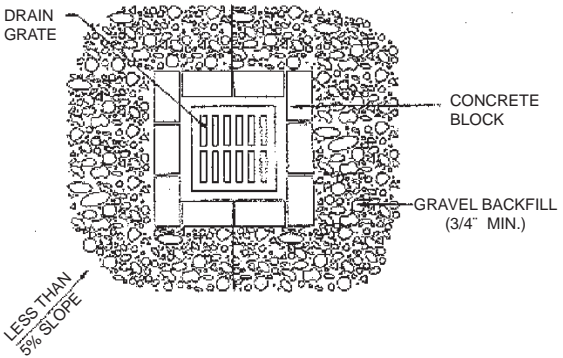

Source: Florida Erosion and Sediment Control Inspector's Manual

3. Gravel and wire mesh drop inlet sediment filter

- Use where excavation can't be done and surrounding soils are sandy. Use where concentrated flows may be expected but ponding won't damage adjacent areas
- Place wire mesh (1/2" openings) over drop inlet. Wire mesh must extend one foot past inlet on every side. Pile coarse aggregate (3/4"-1/2") on the wire mesh. Pile it 12 inches high and slope the pile 18 inches past the inlet on all sides.

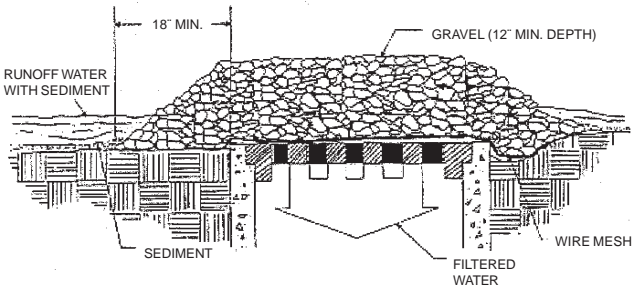

Source: Florida Erosion and Sediment Control Inspector's Manual
62 Sediment Control BMPs

4. Block and gravel curb inlet sediment filter

- Use around curb inlets where an overflow capability is needed to prevent excessive ponding.
- Place two concrete blocks, on their side, on either side of the curb inlet. These are spacer blocks.
- Place a 2x4 stud through the outer holes of the spacer blocks. This is used to hold the front blocks in place.
- Place concrete blocks on their sides in front of the curb inlet and spacer blocks.
- Place wire mesh (1/2" openings) over the outside face of the blocks.
- Place 1.5" coarse aggregate against the wire mesh.

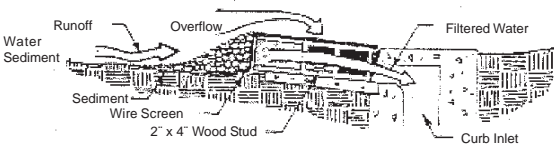
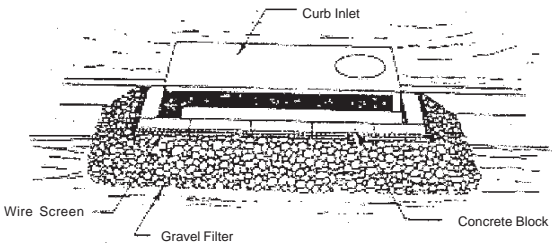

5. Prefabricated storm inlet protection

- Install according to manufacturer's specifications.
- Can be used either to divert flows away from the inlet or create a very small ponding area to trap small amounts of sediment.

picture not available

6. Gravel curb inlet sediment filter

- Use where ponding won't cause damage.
- Place wire mesh (1/2" opening) over curb opening and top of curb.
- Place 1.5" coarse gravel in front of and on top of wire mesh.

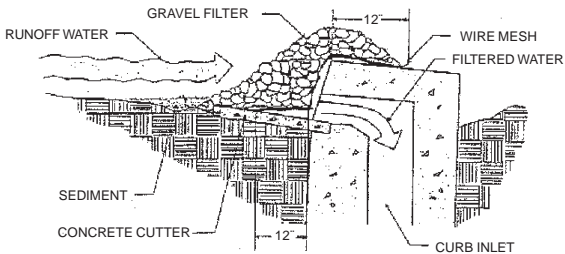

Source: Florida Erosion and Sediment Control Inspector's Manual

7. Gravel filter bags for curb inlet protection

- See picture

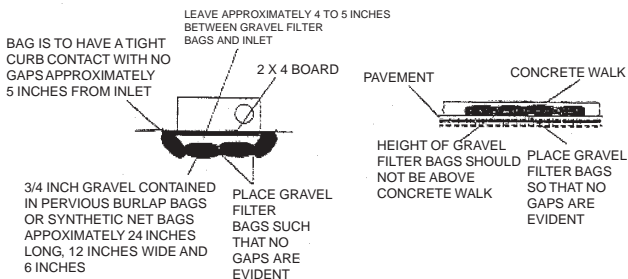

Maintenance

- Inspect the structure after each rain event and repair as needed.
- Remove accumulated sediment when it has reached $\frac{1}{2}$ of the height of filter. Clean filter.
- Remove filter when drainage area has been permanently stabilized.
- If there are unacceptable levels of flooding around inlet protection then remove accumulated sediment; or convert sediment barrier to an excavated sediment trap; or reroute runoff to a more suitable area.

Stream Crossing

Definition

A bridge, ford, or other temporary structure installed across a stream.

Purpose

To provide a means for vehicles and heavy equipment to cross a stream while minimizing damage to the channel and preventing large amounts of sediment from being released into the stream.

Limitations

- Any crossing of a stream will cause some damage. If a stream crossing can be avoided then it should be.
- A bridge will generally cause less damage than a ford or a culvert.
- A properly sized and installed culvert will generally cause less damage than a ford.

Installation

- Select a location for the stream crossing where erosion potential is the lowest. Review the plan to ensure that the number of stream crossings are kept to the absolute minimum.
- Construct the crossing during dry periods and stabilize the crossing immediately.
- Cross streams at right angles.
- Select the gentlest slope for the crossing.
- Stabilize side slopes and approaches immediately in order to prevent erosion (see Check Dam, Diversion, Soil Blanket, and Sediment Barrier)

1. Bridge

- Be sure to anchor one or both ends with a cable or chain to ensure that the bridge won't be moved by a flood.
- Follow the preceding general guidelines.

- Ensure that runoff is diverted off the approaches to the bridge and not allowed to run down to and around the ends of the bridge, thus eroding around the edges of the bridge.

2. Culvert

- Use an 18-inch or larger culvert for stream crossings.
- Install culvert at, or slightly below, the level of the stream bottom.
- Cover culvert with a minimum of 12 inches, or 1/2 the culvert diameter, of earth fill (use whichever is greater).
- If the stream is ephemeral, then a sediment trap or other BMP may be installed immediately downstream.
- Stabilize side slopes and approaches immediately in order to prevent erosion.

3. Ford

- Use fords for crossing wide, shallow streams where normal flow is 3 inches deep or less. Do not place a ford entrance or exit where bank height exceeds 5 feet.
- Lay down filter fabric and cover with 1.5 inch to 3-inch stone.
- Install edging material along both sides to keep stone from being pushed out.
- Ensure that ford and edging material are set no higher than 3 inches above bottom of channel.
- A mat made of timbers cabled together or an articulated concrete mat can also be used in place of rock. Ensure that there are gaps between timbers so that water can flow between timbers.
- Lay down filter fabric and lay matting on top.

Maintenance

Inspect stream crossing after rain. Check for channel blockage, scour, erosion around abutments, or rock displacement. Repair immediately.

Temporary Sediment Trap

Definition

A small ponding area formed by excavation and/or a low embankment across a drainage-way.

Purpose

To detain sediment-laden runoff long enough for some sediment to settle out.

Limitations

- Drainage area must be five acres or less.
- Sediment traps should be in use for 18 months or less.
- Do not use in a stream.
- Do not place a drain pipe with the inlet at the bottom of the trap and a silt fence across the inlet or outlet to filter sediment. **That is not how a sediment trap or basin works.**

Installation

- Determine size of drainage area. Sediment trap should have an initial storage volume of 134 cubic yards per acre **drained**. Round off drainage area to nearest whole number.

Drainage Area (acres)	Storage Volume (cubic yards)
1	134
2	268
3	402
4	536
5	670

- Embankment height shall be 5 feet or less.
- Clear pool area and embankment area.
- Remove all vegetation and roots.
- Ensure that embankment fill material is free of roots, organic material, or any other objectionable material.
- Excavate ponding area, if necessary.
- Construct embankment by placing fill material in 8-inch layers. Compact each layer. Side slopes shall be 2:1.
- Set outlet crest at 1 foot to 18 inches below the crest of the embankment.

- Install outlet protection (see Slope Drain for details on outlet protection).
- Seed embankment with temporary seeding within 7 days of construction (see Temporary Seeding).
- Performance of sediment trap can be improved by seeding and/or mulching drainage area (see Soil Blanket).
- Remove trap and regrade when drainage area is stabilized.
- Sediment traps can also be constructed using gravel-filled sand bags as an embankment.
- Excavating around a storm drain inlet will also create a sediment trap.

Maintenance

- Remove accumulated sediment when sediment has filled in 1/2 the original volume.
- Check embankment after each storm event for erosion. Repair as necessary.

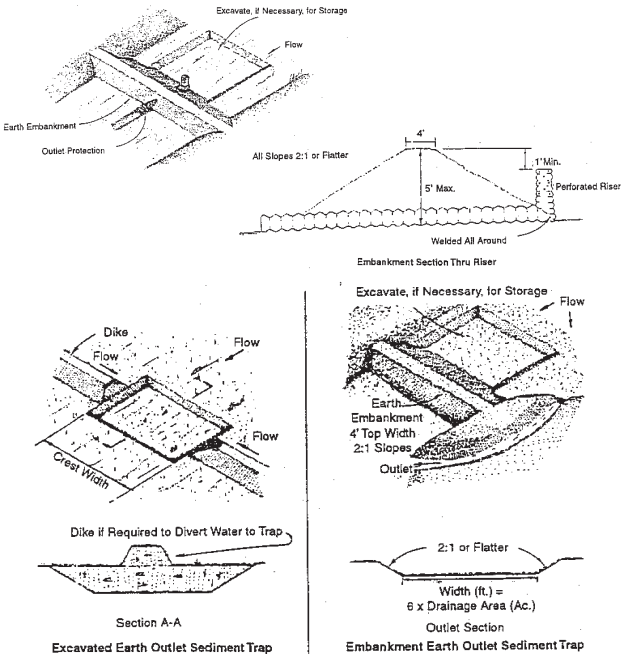

**This page
intentionally
left blank**

Chapter 4

Slope Protection

Slope Cover

Definition

Applying a rolled erosion control product to cover bare soil on a slope.

Purpose

Protects bare soil on a slope from the force of rain, wind and surface runoff. Protects seeds and soil amendments from being washed away. Aids vegetative growth by conserving moisture, suppressing weeds and insulating the soil and seed from temperature extremes.

Limitations

- Do not exceed manufacturer's directions on maximum slope angle for product.
- Some erosion control blankets degrade after a time and some blankets are permanent. Make sure the correct one is specified for the job.

Installation

- Some of these blankets are photodegradable, some are biodegradable, some are permanent and some have seeds and mulch embedded in the matting. Ensure that the right one is used for the job. Consider the use of the area after construction, whether mowing will be done or if this will be an area that carries concentrated, high velocity flows. This will affect the selection decision. For areas that will be mowed, use temporary erosion control netting that has a maximum serviceable life of 3 months or use soil binders. Go to Erosion Control Technology Council website (www.ectc.org) for further guidelines on specifications.
- Nets shall be used to anchor organic mulches on steep slopes and areas with concentrated flows.
- When used with seeding, prepare soil and place seed according to directions in temporary or permanent seeding. Ensure that soil surface is free of rocks, roots or other debris.

- Spread organic mulch.
- Lay down netting on top of organic mulch ensuring firm, continuous contact with soil and anchor according to specifications.

1. Gentle or Short Slopes

- For gentle (shallower than 3:1) or short (less than 10 feet in length) slopes, netting can be laid horizontally (along the slope). Netting shall be laid in a manner similar to installing roofing paper or shingles, by starting along the bottom of the slope and having each adjoining strip overlap the top 6 inches of the strip below it.
- Start at one side of slope and dig a 6-inch by 6-inch trench up and down the slope.
- Starting at bottom of slope, anchor leading edge of netting in trench and staple in trench.
- Unroll netting along the slope and anchor with staples according to manufacturer's specifications.
- When joining ends (roll wasn't long enough to cover the length of the slope), anchor new net in 6-inch trench, use a 6-inch overlap with old net and staple together.
- Start next strip of netting by anchoring in trench ensuring that there is a 6-inch overlap over the strip below and unroll. Staple overlap together. Stagger end lengths so that there isn't a continuous seam running up and downhill.
- On last strip (strip at top of slope), anchor uphill side in a 6-inch trench as well.
- Backfill trenches and tamp soil firmly.

2. Steep Slopes

- On steep slopes netting shall be laid parallel to slope (up and downhill).
- Dig a 6-inch by 6-inch trench at the top of the slope. Unroll 4 feet of the netting, line trench with netting while leaving 3 feet of netting extended past the trench.

- Anchor netting in trench with staples, backfill and tamp soil firmly. Take remaining 3 foot strip that is extended past the trench and fold over the trench. Fasten strip to netting with staples. Unroll netting down the slope.
- Start at top of slope or grade, anchor net, and work down.
- Where strips are laid side by side, overlap edges 3 inches and staple together.
- When joining ends, anchor new net in trench, overlap with old net 18 inches and staple together below trench.

Maintenance

- Inspect periodically and after rainstorms.
- Check for rills, dislocation, or failures, and repair.
- If washout occurs, then regrade, reseed and remulch.
- If washout continues, check to see if flow velocities or if contributing area are too great and install additional measures to slow velocities and/or divert a portion of the flow.

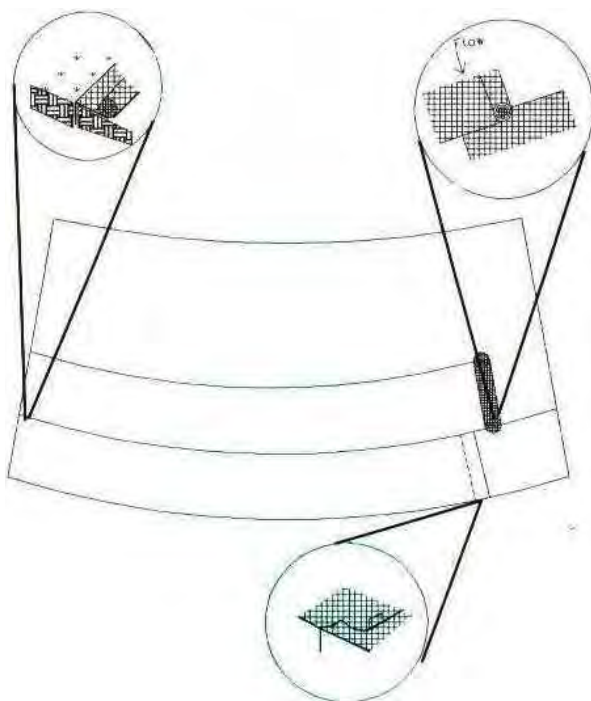

**This page
intentionally
left blank**

Slope Drain

Definition

A tube, conduit or hardened channel that runs from the top of a slope to the bottom.

Purpose

To prevent stormwater runoff from eroding a slope by concentrating runoff and conveying it down the slope safely.

Limitations

- Pipe must be sized according to drainage area and amount of flow expected or a blowout and gully erosion could occur.
- Maximum drainage area per slope drain is 5 acres.
- Care must be taken around the inlet or piping or resulting erosion could occur.
- A stabilized outlet must be provided at the bottom or erosion will occur.
- The slope drain must be firmly anchored.

Installation

- Determine where the slope drain will be placed (using the limitations as a guide) and direct the diversion to that point.
- Size the slope drain to match the area being drained. Use the following table to size the pipe:

Max drainage area (acres)	Pipe diameter (in)
0.5	12
0.75	15
1.5	18
2.5	21
3.5	24
5.0	30

- Slope the entrance section (flared end or T-section) to the slope drain with a minimum drop of ½" per foot.
- Build a dike around the entrance section, both to direct runoff into the slope drain and to anchor the entrance section. Compact the soil around and under the entrance section and build the dike in 4-6 inch lifts, compacting every lift. Make sure the soil around the slope drain is well compacted. This is to prevent piping failure.
- Ensure all sections are securely fastened together and have watertight fittings.

- Anchor the sections with 10 foot or less spacing between anchors and embed anchors into the soil a minimum of 36 inches.
- Construct an apron at the outlet in order to stabilize the outlet and to prevent erosion.

Stable outlet apron

- Excavate an apron pad that is 4 times the outlet pipe diameter (D) wide by 4.5 x D long (but not less than 6 feet) with a depth that 1.5 times the maximum rock diameter (>6") with a tongue that extends under the pipe 0.5 x D.
- Lay down filler fabric and anchor.
- Backfill pad with well-graded riprap, using rock with average diameter (d50) equal to 6 inches.
- Set apron at a zero percent grade.

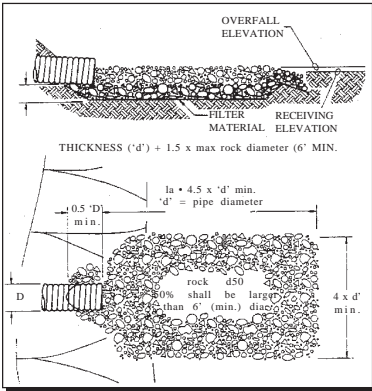

Source: Florida Erosion and Sediment Control Inspector's Manual

Maintenance

- Check after every rain for piping around the outside of the slope drain. Repair and re-compact soil as needed.

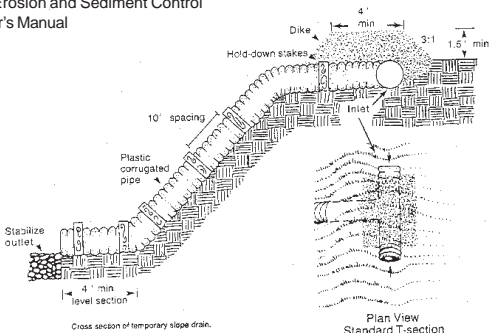

Source: Mississippi's Planning and Design Manual for Control of Erosion, Sediment and Stormwater.

Slope Length Reduction

Definition

Reducing slope length through the use of a sediment barrier.

Purpose

Reducing slope length reduces the velocity of flow down a slope thus reducing erosion potential.

Limitations

- Use before final grading or in bio-technical slope protection.

Installation

1. Fiber rolls

- Install on contour. Decrease spacing between rolls as steepness increases (see table).
- Scrape a shallow trench along contour.
- Ensure trench is even and free of rocks, roots or debris.
- Lay fiber roll in trench.
- If using more than one fiber roll, ensure that ends are pushed tightly together.
- Drive manufacturer-provided stakes into fiber rolls, ensuring that a stake is driven in within 6 inches of each end and 4 foot spacing for all other stakes. Ensure that stakes are driven a minimum of 6 inches into the ground.

Slope (percent)	Spacing
<2	100 feet
2 – 5	75 feet
5 – 10	50 feet
10 – 20	25 feet
>20	15 feet

2. Silt fence

- See Sediment Barrier

3. Continuous Berm

- Install on contour. Decrease spacing between berms as steepness increases (see table above).
- A continuous berm is extruded using a specialized piece of equipment and someone trained in the operation of the machine.

Maintenance

- Inspect after every significant rainfall and weekly.
- Check for displacement. If displacement occurs, repair and re-anchor.

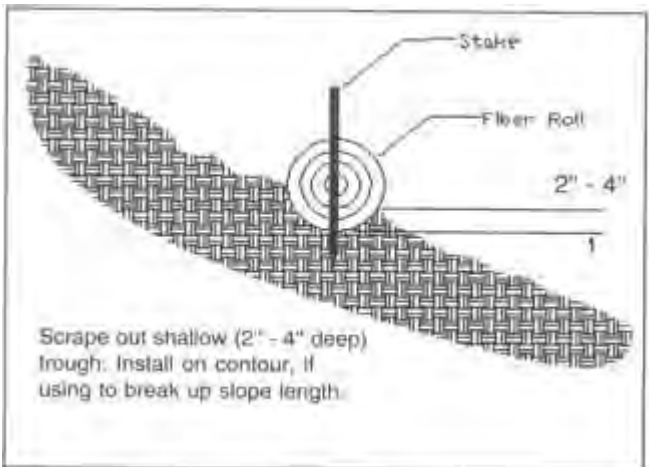

Slope Surface Roughening

Definition

Roughening the soil on a bare slope with grooves or terraces that run perpendicular to the direction of the slope.

Purpose

Loosens compacted soil on a slope that has been cleared and graded, cut, or filled as well as creates small grooves or terraces which reduce runoff velocity, trap seed, fertilizer and sediment, and provide more favorable conditions for vegetation establishment.

Limitations

- Beware of excessive compaction (Remember that the intent of this practice is to loosen and groove soil, not compact it).
- Different methods and equipment should be used on different types of slopes.

Installation

- Cut slopes that will not be mowed can either be “stair-stepped” or grooved.
- If stair-step grading, then make sure that the horizontal part of each step is longer than the vertical and slightly sloped into the vertical. Make individual vertical cuts no higher than 24 inches (36 inches if cutting into rocky material).
- If grooving the slope, then any appropriate implement, such as a disk or tiller, which can be safely operated on the slope, can be used. A bulldozer can groove a slope by being driven up and down the slope (rather than along the slope) thus creating grooves perpendicular to the slope with its tracks.
- Cut grooves on the contour (perpendicular to slope).
- Ensure that depth of cut is greater than 4 inches and that grooves are cut less than 15 inches apart.
- Fill slopes that will not be mowed should be placed in lifts and compacted with the final lift being 4 to 6 inches deep and loose.
- Groove slope.

- Slopes that will be mowed should be grooved with shallow grooves 1 to 3 inches deep and no further apart than 10 to 12 inches.
- Place seed and mulch per guidelines in seed and soil blanket sections. Place as soon as possible and not more than 7 days after final grading and roughening.

Maintenance

- Inspect after every significant rainfall and biweekly.
- Check for rills, gullies, and seed germination.
- If rills or gullies are forming, then fill with loose fill, re-groove, re-seed and mulch.
- If slope has less than 50% cover after 21 days, then reseed per guidelines in seeding section.

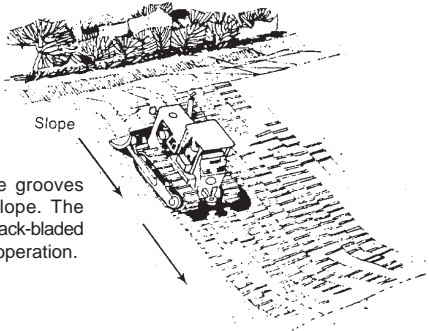

Bulldozer treads create grooves perpendicular to the slope. The slope face should not be back-bladed during the final grading operation.

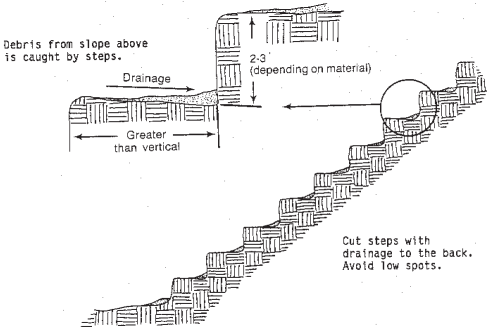

Stair stepping cut slopes

Source: Mississippi's Planning and Design Manual for Control of Erosion, Sediment and Stormwater.

**This page
intentionally
left blank**

Chapter 5
Inspector's Checklist
And
Troubleshooting Chart

¹SITE INSPECTION

Inspections don't "just happen". A great deal of planning and preparation goes into a proper and thorough inspection. Inspectors need to review construction plans, attend preconstruction conferences and be knowledgeable of the law and standards. Knowing why a site is or is not in compliance is a key part of the inspector's duty.

The inspection

An erosion control plan is designed to minimize erosion and control sedimentation. However, components of the plan may fail or the responsible party may not adhere to the plan. As an inspector of construction sites, your job is to be certain:

1. That all erosion and sediment control measures in the approved plan have been properly installed and maintained.
2. That erosion is being controlled.
3. That off-site sedimentation is being prevented.
4. That no turbidity in adjacent streams is being generated.

It takes time to learn how to inspect a construction site properly. Project sites are often large and can have many land-distributing activities occurring at the same time, which can be confusing. Also, there are many considerations to keep in mind while conducting the inspection. You must be familiar with the rules, and many erosion and sedimentation control practices. With some experience, however, you will soon feel comfortable making an official erosion control inspection.

A proper inspection requires planning and a systematic approach. With careful preparation, you can carry out your duty and work cooperatively with all responsible parties so that those involved can do their jobs efficiently.

¹The Inspector's chapter is taken from the Florida's Erosion and Sediment Control Inspector's Manual. Some changes have been made to make this applicable to Mississippi.

Tolerances

The inspector must be reasonable regarding dimensional and performance criteria while performing inspections. This requires an understanding of the intended function of the various BMPs. Obviously a catch basin with an opening designed to support a grate has a zero tolerance for being too small because the grate will not fit. If the opening is one-half inch too wide, the grate will fit and still be supported by the sill or lip. If the opening is two inches too wide, the grate will fall in. This dimensional tolerance can be described as “half inch plus, zero minus”.

A stormwater pond is often designed with 1 foot of freeboard over the riser or spillway. High spots or slightly low spots will probably not affect the performance of the pond. On the other hand, it is critical that the lip of a level spreader is installed “perfectly” level. In this situation, high or low spots will both have the effect of producing concentrated flows. Thus, there is almost zero tolerance, plus or minus.

Other situations are not as simple to define. The allowable (minor) amount of mud tracked, or dust generated, from a site may be somewhat subjective. Many factors are involved in determining performance tolerances, such as severity and frequency of infractions, efforts by the contractors, limitations of the technology and products available, and possibly several other factors. However tolerances are determined, it is essential to the integrity of the inspector and the agency that they are applied with consistency and impartiality.

Preparing for an inspection

The first step in inspecting a project is to review plans when first submitted. This review will alert you to potential problems at the site and weaknesses in the erosion and sedimentation control system design. While at your office, look for the following items in the plan. (There are other items that you may want to include as you gain more experience.)

1. Check contour maps and available aerial photos to see how the water flows through the site. Note where water enters and leaves the site. Determine the direction of flow in the general area and in the watershed where the project is located.
2. Note whether the site borders a sensitive area such as a stream or high quality water body. The boundary should be especially well protected from sedimentation.
3. Pay particular attention to critical areas such as step cut-and-fill slopes, stream crossings, channels, outlets of pipes and diversions, construction access routes and highly erodible soils.
4. Look for adequate access and space to maintain erosion and sediment control measures.
5. Make sure that the plan provides an installation sequence for measures to control erosion and sedimentation, with measures for one phase being installed before grading of the next phase begins.
6. Study the construction schedule to determine whether long periods of time exist between phases of construction. If so, temporary seeding or other temporary soil stabilization will be required.
7. Check to make sure that the plan requires all surfaces to be stabilized as soon as possible after completion of the project and within seven working days. Temporary and permanent seeding should also be specified.
8. Remember that when the contractor is finished, the entire site should be stabilized - no accelerated erosion and no off-site sedimentation should occur.
9. Be sure that the perimeter of the site is protected to prevent off-site sedimentation and keep off-site runoff from flowing across highly erodible areas during construction.

10. Make sure that maintenance plans are adequate and the contractor's procedure in monitoring the performance of control measures is specified. For example, it should be clearly specified whether the general contractor, subcontractor, or construction manager is to do the inspection and maintenance.
11. Note any proposed borrow or waste areas and proposed measures for controlling erosion and sedimentation there.
12. Watch for existing areas that may not be in compliance, such as old highways and abandoned railroad rights-of-way. Those parties responsible for the land disturbance are responsible for erosion control even if ownership of the property has changed.
13. Make a list of the specific items of the plan that you want to inspect closely when you get to the site. This list can speed your inspection and remind you to check certain important points.
14. Reviewing the erosion and sedimentation control plan should provide you with a solid grasp of the proposed project. From the review you can identify parts of the erosion control system that may need to be strengthened and parts that should be watched carefully to see if the performance requirement is met. Your experience in the field and in the geographical area will provide valuable assistance in the approval or revision of the submitted plan.
15. Inspectors must also be familiar with the construction plans. Study these plans; identify and highlight sensitive areas, BMP placement and details, and other items of concern.

The ability to read aerial photos is important because some construction projects now use aerial photos on which to draw the construction plans. It will take some practice to be able to recognize ordinary objects from the air.

Many experienced people have found that aerial photos and topographic maps can help greatly in determining the

effects of a project on the surrounding area. Aerial photos can be obtained from the local Soil and Water Conservation District. The Mississippi Department of Environmental Quality, Office of Geology is a good source for topographic maps. These maps are drawn on a scale of 1:24,000.

Review of the construction plan provides information needed for the next step of the inspection process, the preconstruction conference. Use the suggestions below to ensure that you are fully prepared for the conference.

Preconstruction conference

A preconstruction conference is one of the most valuable vehicles by which you can address and divert many potential erosion and sedimentation problems before they become catastrophes. This conference provides an opportunity for you to meet face-to-face with the responsible party and the contractor. In this way, you can establish the expectations for the project and start a good working relationship with the job superintendent. While holding the conference, keep the following suggestions in mind:

1. Clarify the objective of erosion and sediment control and inform all parties about the specific requirements for compliance in this project. Also, discuss the inspection procedures and establish communications and scheduling so that everyone knows what will be happening during the project.
2. Designate a contact person for communicating concerns about erosion control. This will make future contacts much easier.
3. Be sure that all parties review a copy of the approved erosion and sediment control plan so that they know what is expected, and are prepared to carry out the plan.
4. Inform the responsible party and the contractor that the program is performance oriented and that the plan may need to be changed during the course of construction. Inform all parties about procedures for changing the plans.

5. Try to hold the conference on the site. There, the group can walk the site and compare the plans to see if the measures are appropriate, are located properly, and can be maintained once installed. Determine areas where sediment from the sediment traps and basins can be placed and stabilized when the devices are cleaned. The site is also the best place to determine if adequate access will be available to maintain the erosion control measures.
6. Discuss the schedule of clearing and grading. Emphasize that sediment control measures should be installed before the actual grading begins in order to capture sediment as it is generated. Be sure that the schedule allows for stabilizing surfaces with temporary and permanent measures during and between phases of grading and construction.
7. Discuss the maintenance requirements so that the responsible party and the contractor know who is responsible for inspecting, cleaning and repairing the measures. Regular inspection and maintenance may need to be supplemented with extra work if there is a forecast of a large storm, or to clean up after a large storm.
8. Establish open communications at the preconstruction conference; this provides a good foundation for your relationship with the responsible parties during the project.

Before you leave the office

Take the time to review the plans thoroughly before you go to the site, even if you have already reviewed them when they were first submitted.

1. Outline your approach for each inspection. It is necessary to know in detail the erosion control system and why each measure is specified.
2. Always take a copy of the approved plans with you to the site for quick referral.
3. Always bring the project file and necessary reporting forms.

4. Always take equipment for measuring (level, tape measure, turbidity sampling kit, etc.) and documenting (camera, camcorder).

Inspecting the site

At the construction site, ask yourself the following five questions:

1. Does this project have an approved permit?
2. Is the erosion and sediment control system installed as shown on the approved plans?
3. Is erosion being controlled on the site?
4. Is sediment being contained on the site?
5. Is the potential for turbidity in adjacent streams minimized?

If the answer to *all* of these questions is YES, then the site is in compliance. File an inspection report stating that the site is in compliance and take field notes to support the inspection report. It is a good idea to keep track of the sites where the erosion and sedimentation control plans work well so that you can show others examples of good sites.

If the answer to *any* of the above questions is NO, then the site is not in compliance. File an inspection report listing the items that are not in compliance. Your field notes should describe precisely the noncompliance and its location. Remember that others may need to use your field notes, so make them readable and understandable. The following points will help you in checking for compliance.

1. Carry a set of the approved plans to the site for your reference. They are necessary to determine what measures make up the erosion control system and how they are to be installed and maintained.
2. Take detailed, orderly field notes as you do the inspection. Eventually, this procedure will save you time and possibly a second trip to the site. Be sure that your notes are neat, concise and complete (remember, your notes may be needed as evidence in court).

3. Check in with the job superintendent when you arrive so that the contractor knows who you are and what you are doing. When possible, schedule appointments so that the contractor and other responsible parties know when to expect you.
4. Walk the perimeter of the site on your first inspection. This procedure will give you a good idea of the terrain and will alert you to any problems occurring from off-site water and off-site sedimentation.
5. You may want to start your inspection from the lowest point of the perimeter and work your way upstream through the stormwater management system. This helps to make you aware of the amount of sediment leaving the site and can help you in locating its source.
6. If sediment is flowing off the site, go far enough downstream to see the extent of the damage. In these situations, it is very important to document the damage. Make an estimate of the sediment volume. Photos and videotapes make very good evidence. Be sure to write the time, date and other items in your notes and on the inspection report.
7. If turbidity is present in nearby water, sampling of the stream upstream and downstream of the discharge point can provide the best possible evidence that the site is in or out of compliance.
8. Bring necessary tools to measure the devices and disturbed areas in the field. Be sure that basins and traps are sized according to the plans; channels and diversions have the proper grade, and contributing areas for the control devices are no larger than those used in the design.
9. Pay particular attention to the maintenance of erosion and sediment control measures. All measures require regular maintenance and may require special attention after severe storms.

10. Keep in mind that when certain structural measures fail from improper installation or maintenance, more off-site sediment damage may occur than if the device had not been installed.
11. Always fill out an inspection report for each trip to a site while you are still at the site. The pertinent inspection points are still fresh in your mind and you can easily recheck items that may be in question.

Causes of noncompliance

When you find a site that is not in compliance, it is important to determine why. By determining the cause(s), solutions become more apparent. Problems of erosion and sediment control on sites fall into three categories:

- A. The responsible party has not made efforts to comply with the rule.
- B. There are design errors in the erosion control system or the site conditions have changed.
- C. The installation or maintenance of a measure is faulty or inadequate.

A. Little or No Effort to Comply

Noncompliance in the first category is easy to spot. The responsible party may believe that the project does not come under the jurisdiction of the rule or may intentionally disregard the provisions of the rule. Quite often these sites are found by inspectors while driving by, or a complaint is made by the general public. Therefore, be observant in your territory. Once you have found a noncomplying site, inform the responsible party that compliance is mandatory by law. On the inspection report, note that the responsible party has been informed of the law and list the items that are not in compliance. Appropriate enforcement action should then be taken. These are some of the causes of noncompliance within this category:

1. Not submitting a plan.
2. Failing to follow the approved plan.

B. Inadequate Design or Changes in Site Conditions

Violations and failures may occur because the design was inadequate or the site conditions have changed since the plan was prepared. In this event, the plan needs to be revised and approved. The inspection report should note all items of noncompliance and the need for a revised plan.

Compare the original design in the plan to conditions in the field. Look for changes in the site, conditions and construction plan. Ask yourself the following questions when checking for violations caused by design errors and changes:

1. Are the planned measures retaining the sediment on the site?
2. Are there modifications to the plan?
3. Are ground covers adequate for the slope and orientation of the areas to be protected? Is the slope too steep for the ground cover chosen?
4. Is the perimeter protected, given the conditions at the site?
5. Has the contributing drainage area changed significantly, thereby potentially overloading the control measures? Are additional control measures needed?
6. Is the planned and ongoing maintenance adequate for the existing conditions?

Again, appropriate enforcement action should be taken.

C. Faulty Installation and/or Poor Maintenance

Most noncompliance occurs because measures were not installed correctly or maintained properly, or both. Determining the reasons why the measures are failing requires technical knowledge about the devices and how to construct them properly.

In the following three sections, you will find ideas on how to inspect erosion control devices, stormwater management systems, vegetative practices, and what to look for in their construction.

INSPECTING INDIVIDUAL PRACTICES

The effectiveness of an erosion and sediment control system depends on the design, installation, and maintenance of the individual practices. It is only when all three efforts have been done properly that the system will function to prevent accelerated erosion and off-site sedimentation.

Each practice has specific requirements to function properly. Inspectors must be familiar with these requirements to ensure that each practice has been designed, installed and maintained properly. When you are inspecting a practice in the field, first check that the practice has been installed according to the design specifications on the approved plan. If the practice has been installed as shown on the plan, then check the appropriate section in this chapter for items that should be given special attention for each practice group.

Entrance and Exits

Erosions can be a special problem around all entrances and exits, access roads and construction roads. Erosion in these places can cause mudholes, gullies, muddy pavement, dust, and complaints from neighboring landowners. Construction roads, even temporary roads, need to be stabilized to prevent erosion. Look for the following while conducting your inspection:

1. Entrance and exit pads should be built with coarse gravel and stone that are sufficient to prevent tracking of sediment onto streets or other public rights-of-way and prevent the pad from sinking into the soil.
2. Sites with heavy clay soils may require the installation of a wash rack to control tracking of sediment onto road.
3. On unstable or wet soil, the stone should be spread over a layer of geotextile fabric to keep the stone from being pressed into the soil.
4. Pads may need to be extended to be effective.
5. All runoff from construction roads should be diverted to sedimentation traps to retain sediments on the site.

6. Pads and roads must be maintained (adding more clean stone) to ensure proper functioning.
7. Public roads must be swept as required to keep them free of sediments and stone from the site.

Inlet protection

Inlet protection prevents sediment from entering the storm drains and leaving the construction site. By using inlet protectors (excavated, fabric, gravel, block and gravel, or prefabricated filter bags), the designers can make use of the storm drains to discharge storm waters during construction. Look for problem areas within each of these practices.

Excavated Drop-inlet Protectors

1. If sediment has filled the excavated pool around the inlet, the contributing area for the inlet may be too large or the inlet protection structure may not have been maintained properly.
2. The capacity of the excavation around the drop-inlet protectors must be adequate for the contributing area. Also, the excavated area should be frequently cleaned and maintained.

Fabric Drop-inlet Protectors

1. These structures frequently fail because the posts are not set against the inlet and the tops of the posts are not supported or braced to one another.
2. Water should fall directly into the inlet opening, not onto the unprotected soil around the inlet box.
3. The fabric must always be buried at the bottom to prevent undercutting and to provide structural strength. The fabric should be set a minimum of 12 inches in the soil, and the trench backfilled with compacted earth or crushed stone.
4. Drop-inlet protectors should be set low, no more than 1.5 feet high, to allow water to flow over them without collapsing, and to prevent water from overflowing the

pool behind the fabric, thus bypassing the storm inlet. In some cases, a dike may be required to prevent bypassing.

Gravel and Block and Gravel Inlet Protectors

1. Gravel and block and gravel inlet protectors should be set low, no more than 2 feet high, to prevent water from overflowing the pool and bypassing the structures. The blocks must be set against the base of the inlet for support and to prevent erosion between the blocks and the inlet. A few blocks must be set on their sides to allow the pool to drain.
2. The stone used for the gravel inlet protector should be large enough that it will not wash into the inlet. The slope of the inside face of the gravel must not be too steep or the gravel will fall into the inlet. A few blocks must be set on their sides to allow the pool to drain.
3. The fine, “washed stone” must be on the outside face of the gravel inlet protector in order to slow the flow of the water through the larger stone. The fine stone does not filter the sediment from the water. Sediment drops out of the water because the velocity is reduced when the water is pooled behind the inlet protector.
4. Gravel and block and gravel inlet protectors require flat approaches with adequate storage to allow sediment to settle.
5. A dike may be required on the low side of the pool to prevent runoff bypassing the protector.

Prefabricated Filter Bag

1. Remove the grate and then remove the sack when sediments are within one foot of the grate. Proper use of heavy equipment will help avoid accident or injury.
2. The bag may be replaced, or it may be emptied, cleaned, and reused.

Sediment Traps and Barriers

Sediment traps, basins, and barriers are used to retain sediment on the site to protect streams, lakes, drainage systems, and adjacent property. These devices are used at the outlets of channels, diversions, and other runoff conveyance measures to allow sediment-filled water to pool and sediment to settle. These measures are often used as the last line of defense to stop sediment from leaving the site; therefore, inspect them closely.

Sediment Traps

1. The drainage area must be limited to 5 acres or less.
2. The size of the sediment pool must be adequate for the disturbed area.
3. The spillway of the sediment pool must be large enough to carry the design flow. The crest of the spillway should be level to allow even distribution of flow.
4. Geotextile fabric (filter cloth) must be installed under the outlet section to prevent undercutting.
5. The slopes of the inside and outside faces of the outlet section must not be greater than 2:1 to prevent stone from washing away.
6. The earth dike forming the basin must be compacted to prevent it from failing when pool is full. The height and top width must be adequate to hold the water in the pool.
7. The dike must be higher than the outlet weir section or the water will wash out the dike at its lowest point.
8. Sediment traps should be cleaned when the sediment is one-half the design depth to maintain adequate storage volume.

Sediment basins

1. The size of the sediment basin must be adequate for the disturbed area. Limit the drainage area to 100 acres or less.

2. Sediment basins require special attention because their large size makes them very hazardous if they fail. Thus, it is important that sediment basins are carefully constructed to follow the dimensions, grades, elevations, pipe sizes, emergency spillway sections and other specifications as shown on the approved plans.
3. The conduit must be installed and function properly. The conduit joints must be watertight and must have anti-seep collars to prevent piping along the conduit.
4. Anti-flotation weights must be used to prevent conduit movement.
5. The soil in the embankment must be compacted to prevent piping. Hand tamping is necessary around the conduit.
6. Trash racks can cause failures if they are improperly designed. They should catch large debris to prevent the conduit from being clogged but should not have such fine openings that they become clogged with leaves and cause water to overtop the embankment.
7. There should be at least 1 foot of freeboard above the emergency spillway flow depth to prevent overtopping of the embankment.
8. The emergency spillway should be large enough to carry a 25 year, 24 hour storm flow safely without eroding. It should be constructed in undisturbed soil and properly stabilized.
9. Large basins must be accessible to allow frequent cleaning. The sediment removed from the basins should be placed where it will not be lost off-site.

Perimeter Controls (silt fences)

1. Silt fences fail because they are improperly designed, installed, or maintained. Silt fences must be buried at least 8 inches and backfilled with compacted soil or stone to prevent undercutting. These fences must be adequately supported to prevent collapse from the pressure of the water and accumulated sediment.

2. Silt fences should never be placed across streams, conveyances, or areas of concentrated flow. The flowing water will collapse or undermine the fence.
3. Silt fences cannot withstand flows from large areas or steep slopes. The size of the contributing area must be limited to $\frac{1}{4}$ acre per 100 feet of fence.
4. Sediment fences require frequent maintenance. The accumulated sediment should be removed often.

Stream Crossings

Stream crossings must be specifically addressed and allowed by the permit. Inspect stream crossings carefully because any sediment will enter the stream directly.

1. Debris and construction material should be removed from the stream to prevent water cutting around culverts and bridge abutments.
2. Culverts cause additional soil disturbance when they are installed or removed. Provisions should be made to reduce sedimentation in the stream during installation and removal of culverts.
3. Fords should be used only for shallow or intermittent streams. Use geotextile fabric covered with properly sized stone to prevent the stone from being carried downstream.
4. Bridges cause the least disturbance to the stream and should be used where practical.
5. Banks should not be filled to shorten the length of bridge required. Fills restrict the stream channel and can easily wash out.
6. Approaches to stream crossings should be stabilized and should have diversions to prevent runoff from entering the stream.

Buffer Zones

The use of buffer zones to protect streams, lakes, and other bodies of water is always recommended and may be

required. Check for the following points when buffer zones are required on a site.

1. Buffer zones along water bodies must be wide enough to stop all visible sediment in the first one-fourth of the buffer nearest the construction work.
2. Avoid the use of in-stream controls such as check dams, weirs, and the like.

Maintenance

Maintenance of erosion control devices is frequently overlooked on many construction sites. It is one of the most critical points in preventing accelerated erosion and off-site sedimentation.

- 1 The responsible party should provide for continued inspection and maintenance of erosion control practices. Maintenance for a disturbed site should continue through the life of the project.
2. All devices in the erosion and sediment control system should be inspected regularly, but especially after storms. The erosion control plan should specify regular inspections and proper maintenance, such as cleaning and repairs, for each practice.
3. Sediment traps and basins should be cleaned when the settling pools are half full.
4. Contractors frequently run over diversions with heavy equipment, breaking down the dike and allowing overtopping. If the contractor must drive over the diversion, it should be stabilized with gravel and built up to the design elevation above the channel.
5. Silt fences should be repaired immediately if they are damaged.

Remember that the intent of erosion and sediment control regulations are performance-oriented. Even if practices are installed on a site according to the approved plan, the site is only in compliance where erosion and sediment are effectively controlled.

Runoff Control Diversions

Diversions (dikes and channels) should be constructed as shown on the approved plans, or failure of these measures is likely to occur. The most important factors in installing a diversion are its size, the grade, the elevation of the dike above the channel, compaction of the dike, and stabilization of the channel. To help ensure compliance, the following should be evaluated:

1. A dike and its channel must be on the proper grade to ensure that the water flows in the desired direction. **Watch for abrupt changes or reversal of grade on diversions - overflows and failures occur in these places.**
2. Dikes must be large enough to meet the design water flow with 6 inches of freeboard. Be sure that they are sufficiently wide at the top, a minimum of 2 feet and the side slopes are 2:1 or flatter.
3. Dikes must always be compacted because loose soil will wash out.
4. Channels must have a large enough flow area to carry the expected volume of water.
5. Channels on steep grades must be lined to withstand the expected water velocity.
6. Diversions should generally parallel the site contours.
7. Diversions must be maintained routinely for proper performance, with special attention after severe storms.

Runoff Conveyance - Channels, Conveyance Swales, Slope Drains, and Flumes

Runoff must be controlled to ensure that it will not cause accelerated erosion or off-site sedimentation. Channels, swales, slope drains, and flumes must carefully follow the design specifications. Check these key points as you conduct your inspection:

1. Vegetated channels require protection until the vegetation is fully established. Well-anchored sod, mulch, mats, or netting should be used. Water should not be allowed into the system until it is stabilized.

2. Make sure that the flow cross-section is not reduced when riprap is used to line a channel. The channel excavation must be increased (or over-cut) to compensate for the thickness of the riprap.
3. Look to see that channels lined with riprap have a layer of geotextile fabric (filter cloth) under the riprap. Also, the riprap should be inlaid into the channel bank to a depth of 1.5 times the “*d* max” size of the riprap and set into the soil surface to prevent undercutting.
4. Inspect outlets of all runoff conveyances to ensure proper outlet protection.
5. Be sure that the slope drains have watertight joints in the pipe and that the pipe is well anchored to prevent movement.
6. Slope drains frequently fail because the water “pipes” around the inlet to the pipe. Check to see that the soil at the inlet is compacted to prevent piping. Anti-seep collars are also effective in controlling piping.
7. Flumes have steep slopes and carry water at very high velocities. Check that the outlets are stabilized to prevent erosion and that the inlets are designed to prevent water from washing around or under the chute.
8. Determine if the flumes have sub-drains, necessary to prevent hydrostatic uplift.
9. Bends in flumes are difficult to design and build and should be avoided. Check any bends in a chute for signs of overtopping or erosion.
10. Gullies in the channel bottom mean that the velocities are too high. In this case, the channel must be redesigned either by lining the channel to withstand the flow velocities, changing the grade, or altering the channel cross-section to lower the velocity.
11. Sloughing from the channel sides indicates stability problems. Causes of sloughing include a high water table, unstable soils, channel banks that are too steep, or water velocities that are too high.

12. Overbank erosion, or flooding, may result from debris and sediment accumulation. The damaged areas should be rebuilt and the channel re-stabilized according to plan specifications.
13. Sediment below the channel outlet indicates that erosion is occurring either in the channel or its watershed. The problem should be located and corrected.

Outlet Protection

Types of ground cover can be divided into three groups:

1. Hard surfaces
2. Semi-hard surfaces
3. Soft (vegetative) covers

This section provides some ideas on what to look for when you are inspecting a site using ground cover for erosion control.

Hard Surfaces

Hard surfaces are those that include pavement, concrete, and revetment. Some of these surfaces can be cast in place using wooden or fabric forms, or they can be installed in large mats.

1. Look for proper hydrostatic pressure relief for solid slabs or liners.
2. Make sure that lines on channel slopes extend far enough up or away from the water to prevent water from undercutting, overtopping, or bypassing the liners.
3. Be certain that proper vegetation is planted in the hollows of the surface. Also, the soil filling the hollows should be well prepared to provide the best growing conditions for the plants.
4. Watch for accelerated erosion and high water velocities at the toe and top of hard-surfaced slopes and at the outlets from hard surfaces.

Semi-hard Surfaces

Semi-hard surfaces include riprap, gabion mattresses, modular pavement, and grid confinement systems. These surfaces are often used to line channels and cover slopes.

1. Semi-hard surfaces can be washed away by high water velocities. Look for failure by washout, or look for filling of voids by smaller particles to indicate success.
2. Flexible channel liners should be placed to blend with surrounding land surface to ensure that water will flow into the channel without erosion, not along the side of the lining.
3. Check to see if the channel lining is installed according to the plan, has not decreased the cross-sectional area, and is performing properly (i.e. stays in place).
4. Ensure that adequate flow areas have been provided.
5. Semi-hard surfaces should have geotextile fabric or a crushed stone filter underneath to prevent washing of the fine soil particles.
6. Make sure that dust control is being practiced for areas covered with stone aggregates or gravel.

Soft Ground Covers

Soft ground covers (such as vegetative ground covers) are the most common and are used on moderate slopes not exposed to high water velocities. Mulches are sometimes used alone as ground cover but require frequent maintenance. In depth information for inspection is found in the following section.

INSPECTING VEGETATION USED FOR EROSION CONTROL

Vegetation protects more area from erosion than any other erosion control measure. Knowing how to choose and establish the proper vegetation can prevent soil loss and sediment problems.

VEGETATION FOR EROSION CONTROL

Vegetative cover is the principal means used to stabilize soil surfaces. With the selection of the proper species and appropriate maintenance, vegetative cover provides inexpensive, long-term protection with moderate maintenance. Construction projects present a wide range of conditions for vegetation. This section describes what to look for when vegetation is used for erosion control.

A vegetative plan is one of the keys to a well-executed project. An effective plan specifies the appropriate plants for each disturbed area, describes proper soil preparation methods and indicates when and where to plant. Vegetation should be established as soon as possible after grading. Planting should be coordinated with construction so that areas do not remain uncovered, thereby reducing unnecessary amounts of runoff and sediment.

Consider the Site and Its Intended Uses

Vegetation works well only if the selected plant species is suitable for the climate, the soil, and the intended use for the area. Remember that at certain times of the year or under special conditions, it may be necessary to use temporary vegetation before establishing permanent vegetation. Ask these questions when you inspect sites using vegetation for erosion control.

1. *Is the plant type appropriate for the soil and the slope?*
Plants must have fertile, well-prepared soils to grow properly, a requirement rarely met on a graded slope. Heavy, dense sub-soils may be too infertile to support certain plants. Graded slopes may be too steep or too rocky to prepare adequate seedbeds. Steep slopes may need to be sodded or covered with riprap or concrete.

2. *Is the plant properly chosen, given the climate and orientation of the area?*

It is very important that the right plant be placed in the right location for the most effective use. The local Soil and Wa-

ter Conservation District, the county agent, or a qualified nursery can provide guidance.

3. Is the vegetated area being maintained?

Frequently, the degree of maintenance required to keep a certain type of plant growing is overlooked. The responsible party must provide higher maintenance for some ornamental shrubs and grasses. Also, check that the maintenance crews can reach the planted area to provide the necessary care.

4. Is the area subject to high velocity flow?

Some areas, such as channels and steep slopes, may require sod, riprap, or concrete linings to prevent erosion.

5. Is the area going to be occasionally inundated?

This would have an effect on what should be planted and where.

Check Seedbed Preparation

Graded areas are usually compacted and have little topsoil when planting is started. If practical, the soil should be tested so that the proper amounts of lime and fertilizer can be added. Check the following to determine if the vegetation will be adequate.

1. Keep in mind the essentials for plant growth: adequate supplies of nutrients, water, and air in the root zone. Slopes that have been graded are often too compacted and smooth to establish plants. It is necessary to apply fertilizer and lime, prepare a proper seedbed, and roughen the surface to provide required nutrients and adequate rooting depth.
2. Fertilizer and lime must be added, and then incorporated to a depth of 4 or more inches by chiseling, plowing, or tilling. This preparation also enhances water and air infiltration to the root zone.

Check for Proper Mulching

Seeded areas should be mulched to protect and help establish erosion control vegetation. Mulching holds the seed and fertilizer in place, protects the soil, and conserves moisture. Mulching also encourages rapid seed germination by preventing soil crusting and insulates the soil against rapid temperature changes. The following points will help you determine if mulching is adequate:

1. Look for a proper thickness of mulch. Few areas can develop a strong growth of vegetation without mulching, and mulches are often too thin to be of much help. Mulch must be thick enough to cover the ground so that no dirt is seen, but no more than 1 - 2 inches thick.
2. Mulch needs to be well anchored to work properly. This requirement is often overlooked, causing many failures and much added expense for re-seeding. On flatter slopes, mulches can be anchored by spraying on tacking agents that bind the mulch, preventing it from being washed or blown away. Crimping also works well on flatter slopes and level areas.
3. For steeper slopes, mulches overlaid with netting or mats should be used. Netting and mats should be anchored with long staples at the proper spacing to provide the best resistance to washing. Thicker and more durable mats should be used on steep slopes, areas that are exposed to high-velocity flows, and areas where vegetation needs more help to become established.

Ensure Maintenance of Vegetative Cover

Maintenance is the key to adequate erosion control vegetative cover. The inspector must ensure that the vegetation is protected to allow the best germination and strongest growth. Even after the vegetation has emerged, mulches and mats must be maintained to prevent washing during the next rain.

Watch for areas where the mulch is too light - the mulch can blow away or wash away in the next rain. The owner/developer must have new mulch applied and must anchor it to prevent washing.

Damage to seeded areas usually happens where the mulch is improperly anchored. These areas will require immediate repair. The responsible party should fill the eroded area if needed, apply new seed, lime, and fertilizer, and apply an adequate layer of well-anchored mulch. If the area is in a zone where the erosion potential is high or if the practice called for in the plans is inadequate, the responsible person may need to use a heavier mat to provide more protection for the vegetation.

Look for a means of access to the vegetated areas. The responsible party cannot provide maintenance if crews cannot get to the area. This is especially important for areas where high-maintenance ornamental shrubs and turf grasses have been planted.

Routine Inspections: Advise the contractor that you will be monitoring this site for proper installation and diligent maintenance of BMPs.

Final Inspection: A final inspection will be performed when all permitted improvements have been completed. Inform the contractor about documents that will be required at that time (i.e. operating permit, post-construction certification, As-built drawings, etc.)

Penalties for non-compliance: Save the best news for last.

Inspect the site

Walk or drive around the site with the contractor. Point out any potential problems on or off-site areas. Tell the contractor what you will be looking for on future inspections.

Affirmation

Provide the owner/contractor with a copy of your checklist and make sure again that everything has been discussed and clearly understood. Note any clarifications, agreements, and unresolved issues. Sign and date all copies and have them do the same.

Routine Inspection – Maintenance Inspection

Control measure	Problems to look for	Possible remedies
Vegetation	Rills or gullies forming	Check for top-of-slope diversion and install if needed.
	Bare soil patches	Fill rills and regrade gullied slopes, revegetate.
	Sediment at toe of slope	Remove sediments, revegetate using site appropriate methods.
Dikes	Gully on slope below dike breach; wheel track or low spot in dike	Add soil to breaches or low spots and compact.
	Loose soil	Compact loose soil.
	Erosion of dike face	Line upslope face with riprap, or revegetate using site appropriate methods.
Swales	Gully on slope below swale	Repair breaches.
	Wheel track, low point (water ponded in swale)	Build up low areas with compacted soil or sandbags or rebuild swales w/ positive slope.
	Sediment or debris in channel	Remove obstructions.
	Erosion of unlined channel surface	Mulch and install anchored sod or erosion control blanket; or line swale w/ riprap; or install check dams; or realign swale on gentler gradient; or divert some or all stormwater to a more stable facility.
	Erosion of channel lining	Install larger riprap; or reseed; mulch, and anchor w/netting; or install check dams; or pave swale.
Pipe slope drain or flume	Blocked inlet or outlet	Remove sediment and debris.
	Runoff bypassing inlet	Enlarge headwall or flare out entrance section.
	Erosion at outlet	Enlarge riprap apron and use larger riprap; or convey runoff to a more stable outlet.

Grassed waterways	Bare areas	Revegetate w/ anchored sod or erosion control blanket; divert flow during establishment period.
	Channel capacity reduced by tall growth	Mow grass
Riprap lined waterway	Scour beneath stones	Install proper geotextile or graded bedding. Make sure edges of geotextile are buried.
		Replace w/ larger stones
Outlet protection	Erosion below outlet	Enlarge riprap apron; or line receiving channel below outlet; or convey runoff directly to a more stable outlet. Make sure discharge point is on level or nearly level grade.
	Outlet scour	Install proper geotextile or graded bedding beneath riprap apron.
	Dislodged stones	Replace w/ larger stones
	Sediment level near outlet elevation	In traps, remove sediment if less than 1 ft. (0.3 m) below outlet elevation; in basins, remove sediments if less than 2 ft. (0.6 m) below top of riser.
	Obstructed outlet	Remove debris from trash rack.
	Basin not de-watering between storms	Clear holes. Clean or replace sediment-choked gravel surrounding de-watering hole or subsurface drain.
	Damaged embankments	Rebuild and compact damaged areas.
	Spillway erosion	Line spillway w/ rock, geotextile, or pavement.
	Outlet erosion	Make sure outlet is flush w/ ground and on level grade. Install, extend or repair riprap apron as required; or convey discharge directly to a more stable outlet.
	Riser flotation	Anchor riser in concrete footing.

	Excessive discharge to and from basin or trap	Check runoff patterns for consistency w/ plans. Reroute part of volume to another basin or enlarge the basin.
	Sediment storage zone fills too quickly	Increase size of basin; or stabilize more of the contributing area.
Straw bale barrier *recommend to the contractor that other methods be utilized*	Bale displacement	Anchor bales securely w/ proper stakes or rebar. Check drainage area, slope length and gradient behind each barrier.
	Undercutting of bales	Entrench bales to proper depth, backfill, and compact the soil.
	Gaps between bales	Re stake bales. Drive first stake in each bale at an angle to force it snug against the adjacent bale.
	Baling wire broken	Retie bale or replace w/ fresh bale
	Bale disintegrating	Replace w/ fresh bale.
	Runoff escaping around barrier	Extend barrier or reposition in center of flow path
	Sediment level near top of bales	Remove sediment when level reaches half of barrier height.
Silt fence	Undercutting of fence	Entrench fabric to proper depth, backfill, and compact. Check compaction
	Fence collapsing	Check post size and spacing, gauge of wire mesh and fabric strength. Check drainage area, slope length and gradient behind barrier. Correct any substandard condition.
	Tom fabric	Replace w/ continuous piece of fabric from post to post, attach w/ proper staples.
	Runoff escaping around fence	Extend fence uphill.
	Sediment level near top of fence	Remove sediment when level reaches half of fence

		height or install new fence in close proximity.
Check dam	Sediment accumulation	Remove sediment after each storm.
	Flow escaping around sides of check dam	Build up ends of dam and provide low center area for spillway.
	Displacement of sandbags, logs or stones	Check drainage areas and peak flows. Reinforce dam w/ larger stones, etc.; or divert part of flow to another outlet.
Inlet protection	Flooding around or below inlet	Remove accumulated sediment; or convert sediment barrier to an excavated sediment trap; or reroute runoff to a more suitable area.
	Undercutting of bales or silt fence, bale displacement, torn fabric, etc.	See remedies for straw bale barriers and silt fences.

Final Inspection

General

- Are all Final Inspection documents in order (As-Built drawings, Compliance Report, Post-construction Certification, Operating Permit, etc.)?
- Are all applicable easements recorded with the Clerk of the Court?
- Are the roads, buildings, parking, sidewalks, etc. as shown on plans?
- Is there any significant change in impervious area?
- Did natural or undisturbed areas remain that way?
- Are all utilities installed (not necessarily hooked-up)?
- Are there any outstanding violations or fees?
- Is there any off-site disturbance or adverse impact from this project?

Stormwater Facilities

- Is the stormwater management facility where it (they) should be?
- If the facility is underground, is there access for maintenance?
- Is the facility the size and depth it should be?
- Are the slopes as shown on plans and stabilized?

- If applicable, is the stormwater facility fenced?
- Are the control structures as shown and clean?
- Is the filter system as shown and clean?
- Are energy dissipaters as shown and stabilized?
- Is the pond bottom free of sediments?
- Are aquatic plantings installed as shown and in good condition?
- Does the facility meet minimum performance standards as permitted (treatment and volume recovery)?

Stormwater Conveyance

- Is the conveyance system as shown, free of debris and stabilized?
- Are all inlets as shown and clean?
- Are roof drains as shown?
- Is all water on site directed to ponds, except access-ways?

Landscaping/Natural Areas

- Are natural buffers existing and undisturbed?
- If buffers were to be augmented, have they been?
- Can buffer areas be accessed for maintenance?
- Are landscape islands in parking areas as shown?
- Is perimeter landscaping as shown?
- Are all landscape areas protected by curbing, wheel-stops, or other physical barriers?
- Do all landscape areas have access to irrigation?
- Do all plantings conform to the approved landscape schedule?
- Are all seeded areas firmly established?
- Is all sod firmly established, properly anchored?

POINTS OF CONTACT

1. *For information regarding stormwater permitting for construction sites* contact the General Permits Section of the Environmental Permits Division – (601) 961-5171 or on the Internet at http://deq.state.ms.us/MDEQ.nsf/page/epd_epdgeneral?OpenDocument
Note: this contact is for state (NPDES) permitting only. Check with appropriate local government authority for information regarding local stormwater requirements.
2. *To lodge a complaint about erosion and sedimentation problems from a construction site* contact the Construction Section of the Environmental Compliance and Enforcement Division – (601) 961-5171 or on the Internet at http://deq.state.ms.us/MDEQ.nsf/page/Main_Assistance?OpenDocument
3. *For technical assistance or to order a manual* contact the Nonpoint Source Section of the Water Quality Management Branch – (601) 961-5171 or on the Internet at http://deq.state.ms.us/MDEQ.nsf/page/NPS_ManagingPollutedRunoffInMississippi?OpenDocument
4. *For information and assistance regarding wetlands, wetland impacts, and permitting* contact the Water Quality Certification / Wetlands Section of the Water Quality Management Branch – (601) 961-5171 or on the Internet at http://deq.state.ms.us/MDEQ.nsf/page/WQMB_Stream_Wetland_Alteration03?OpenDocument
5. *For information regarding dams (temporary and permanent) and permitting* contact the Dam Safety Section of the Office of Land and Water – (601) 961-5171 or on the Internet at http://deq.state.ms.us/MDEQ.nsf/page/L&W_Dam_Safety?OpenDocument
6. *For assistance on requirements on above ground petroleum tanks and spill prevention* contact the Environmental Protection Agency, Region 4 Emergency Response Program – (404) 562-8752 or on the Internet at

POINTS OF CONTACT

<http://www.epa.gov/oilspill/> In addition, check with the local Fire Marshal and city or county government to find out about any local regulations. For assistance with above ground propane tanks contact the L C Gas Division of the Insurance Department at (601) 359-1064.













7. *For information regarding the proper disposal or recycling of solid waste from a construction site or regarding burning of natural debris from clearing* contact the Construction Section of the Environmental Compliance and Enforcement Division – (601) 961-5171
8. *To report oil or chemical spills immediately* contact the Mississippi Emergency Management Agency at (601) 352-9100 or 1-800-222-6362
9. *For information regarding the proper handling of pesticides* contact the Bureau of Plant Industry of the Mississippi Department of Agriculture and Commerce – (601) 325-3390 or on the Internet at <http://www.mdac.state.ms.us>
10. *For information or technical assistance regarding soil types, erosivity, or assistance with BMPs* contact the local county Soil and Water Conservation District or contact the Mississippi Soil and Water Conservation Commission – (601) 354-7645 or on the Internet at <http://www.mswcc.state.ms.us>
11. *For information regarding tree protection or planting* contact the Urban Forestry Section of the Mississippi Forestry Commission – (601) 359-1386 or on the Internet at <http://www.mfc.state.ms.us>
12. *For information regarding temporary or permanent seeding for erosion control and fertilizer requirements* contact the local county extension agent. You can find the phone number of your local extension agent in the blue pages of the phone book or on the Internet at <http://msucares.com>

ADDITIONAL RESOURCES



1. The International Erosion Control Association – providing information and education about erosion control. On the web at www.ieca.org
2. *Silt Fence That Works* – a complete guide to installing and maintaining silt fence. On the web at www.ieca.org/Bookstore/
3. *Designing for Effective Sediment and Erosion Control on Construction Sites* – a guide to understanding erosion and sedimentation processes and how to design effective control. On the web at www.ieca.org/Bookstore/ or www.foresterpress.com
4. *Planning and Design Manual for the Control of Erosion, Sediment and Stormwater* – Mississippi Department of Environmental Quality, Nonpoint Source Section. On the web at http://deq.state.ms.us/MDEQ.nsf/page/NPS_Publications_Literature?OpenDocument
5. *Construction Guidance Manual* – a guide to developing a storm water pollution prevention plan (SWPPP) as required for coverage under the construction (either large or small) general permit. On the web at http://deq.state.ms.us/MDEQ.nsf/page/epd_epdgeneral?OpenDocument
6. The Erosion Control Technology Council – providing performance standards and guidance on application and installation of rolled erosion control products. On the web at www.ectc.org

Symbols for Erosion and Sediment Control Practices







I. TEMPORARY PRACTICES

-  Check Dam
-  Construction Entrance/Exit
-  Construction Road Stabilization
-  Diversion
-  Dust Control
-  Sediment Basin
-  Silt Fence
-  Slope Drain
-  Storm Drain Inlet Prot.
(Silt fence, straw bale, excavated, block & gravel)
-  Straw Bale Barrier
-  Stream Crossing
-  Water Bar















II. PERMANENT PRACTICES

-  Buffer Zone
-  Concrete Grid & Modular Pavement



III. VEGETATIVE PRACTICES

-  Mulching
-  Permanent Seeding
-  Sand Fence (Wind Fence)
-  Sodding
-  Surface Roughening
-  Temporary Seeding
-  Topsoiling

II. PERMANENT PRACTICES (cont'd)



-  Constructed Wetland
-  Detention Basin
-  Diversion
-  Exfiltration Trench
-  Grade Stab. Structure
-  Grassed Waterway
-  Land Grading
-  Level Spreader
-  Lined Waterway or Outlet
-  Parking Lot Storage
-  Paved Flume
-  Rock Outlet Protection
-  Stormwater Retention Basin
-  Subsurface Drain
-  Underdrains & Stormwater Filtration

III. VEGETATIVE PRACTICES (cont'd)

-  Tree Preservation & Protection
-  Trees, Shrubs, Vines & Ground Covers
-  Vegetative Dune Stabilization

IV. COMPOSITE PRACTICES

(No standard)

-  Vegetative Streambank Stab.
-  Structural Streambank Stab.
-  Riprap

Glossary

Annual - vegetation that completes its life cycle in one year and does not grow back. Areas that are planted with annuals for erosion control must be stabilized with other practices within one year.

Anti-seep collar - a device constructed around a pipe or other conduit and placed through a dam, levee or dike for the purpose of reducing seepage loss and piping failures.

Best Management Practice (BMP) - any practice used which provides the most effective and practical means of preventing or reducing the amount of erosion, sediment, or other pollutants generated from a site to a level compatible with state and local water quality goals.

Conduit - any channel intended for the conveyance of water, whether open or closed.

Downslope - the direction that surface runoff will flow. When a construction site is graded level the term “downhill” is not accurate. However there will be a slope, however slight, which runoff will follow.

Drainage area - all surrounding land where runoff will drain to a selected point. Also known as a watershed.

Ephemeral - a drain or ephemeral stream that may or may not have a well defined channel and only has water in response to a storm event.

Erosion - the process of detaching and moving soil particles from the land surface by rain, running water, wind, ice, or other geological agents. The following terms are used to describe different types of erosion:

- **Accelerated erosion** - erosion much more rapid than natural. Caused by manmade land disturbance.
- **Gully erosion** - erosion that occurs when water accumulates in a narrow (greater than one foot in depth and cannot be easily crossed by equipment) channel and removes the soil from this narrow area, usually in a short period of time.

- **Natural erosion** - the gradual erosion of land caused by natural environmental conditions.
- **Rill erosion** - the erosion process where numerous small (few inches deep and can be easily crossed by equipment) channels are created. Rill erosion will usually be no more than 400 feet in length, after that the water will concentrate in channels.
- **Sheet erosion** - the removal of a uniform layer of soil by runoff or wind. This type of erosion can be deceptive as large sediment loads can be deposited in nearby watercourses without any visible sign that erosion has taken place.

Freeboard - vertical distance between the maximum water surface elevation anticipated in design and the top of retaining banks or structures. Provided to prevent overtopping due to unforeseen circumstances.

Intermittent - an intermittent stream is one with a defined channel and maintains surface water flow for 3 to 9 months of the year during normal climatic conditions.

Non-Point Source (NPS) - a term commonly used to describe pollution coming from an area or many sources rather than out of a pipe from a discrete source.

Outfall - exit point where water flows from a conduit or drain.

Perennial - plants whose life cycle spans several years. Usually these plants go dormant in the winter, but maintain their root systems and will hold soil. This term also classifies streams with a well-defined channel and surface water flow for more than 9 months of the year during normal climatic conditions.

Piping - where water moves along the outside of a pipe or conduit, eroding the soil around the pipe. This removes the support from the pipe and could lead to its collapse over time.

Scour - referring to flowing water eroding soil in an area and creating a pool. Usually occurs at outfalls where protection is not provided.

Sediment - solid material (soil) that is being transported by wind, water, gravity, or ice, usually as a product of erosion.

Sheet flow - water, usually storm runoff, flowing in a thin layer over the ground surface.

Slope - the degree of deviation of a surface from horizontal, measured in numerical ratio, percent, or degrees. Expressed as a ratio or percent, the first number is the horizontal distance (run) and the second number is the vertical distance (rise), as 2:1 or 200 percent. Expressed in degrees, it is the angle of the slope from the horizontal with 90 degrees being vertical and 45 degrees being a 1:1 slope.

Soil - the unconsolidated mineral and organic material on the immediate surface of the Earth that serves as a natural medium for plant growth. Soil is found in layers, called horizons, with the two important ones (as far as erosion control is concerned) being topsoil and subsoil. Topsoil is the top layer of undisturbed soil, consisting of a good percentage of organic matter and conducive to plant growth. Subsoil is the layer immediately below the topsoil layer, containing more clay and less organic matter than the topsoil, and is not as conducive to plant growth.

Swale - an engineered drainage channel with both a flat bottom and gentle side slopes (2:1 or less) or gently rounded, planted in grass.

Turbidity - a measurement of water clarity. The more turbid water is, the cloudier it is.

PROJECT VICINITY

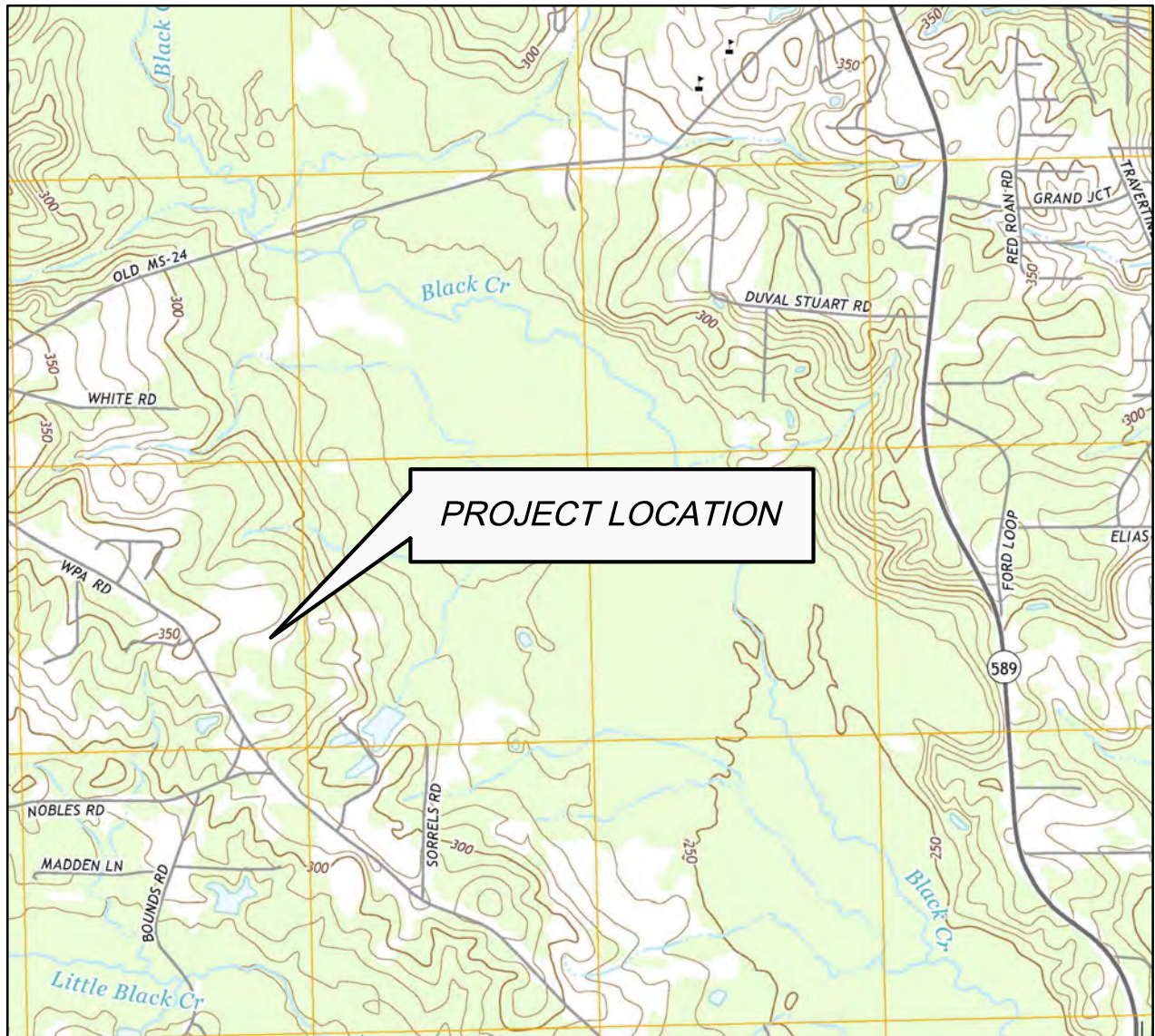
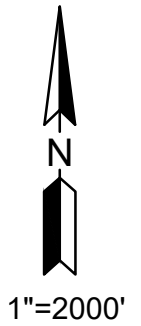

PREPARED BY



P.O. Box 1935 / Purvis, Mississippi 39475
Phone: (601) 794-4565 Fax: (601) 794-4576

PROJECT VICINITY DRAWING

PART OF THE SW $\frac{1}{4}$ OF THE SE $\frac{1}{4}$ OF
SECTION 34, TOWNSHIP 4 NORTH, RANGE 15 WEST
LAMAR COUNTY, MISSISSIPPI